

# Operating Instructions

## **Proline Promass I 100**

### **PROFIBUS DP**

Coriolis flowmeter

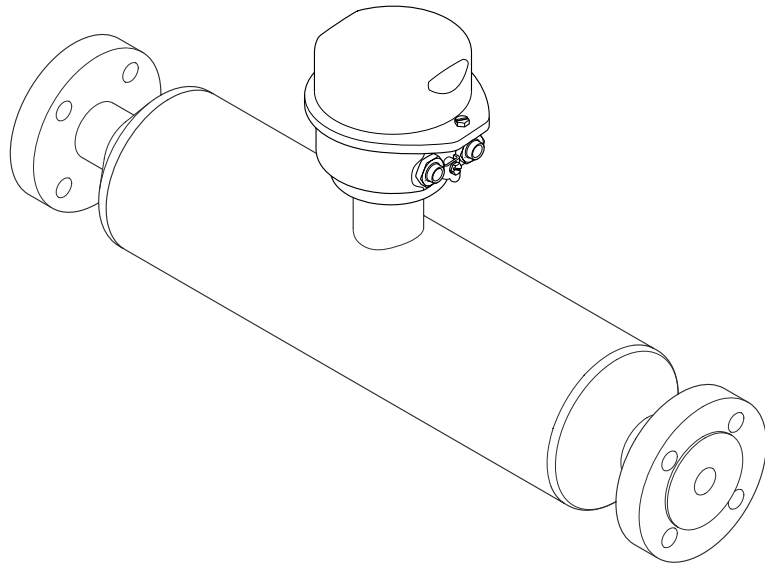

- Make sure the document is stored in a safe place such that it is always available when working on or with the device.
- To avoid danger to individuals or the facility, read the "Basic safety instructions" section carefully, as well as all other safety instructions in the document that are specific to working procedures.
- The manufacturer reserves the right to modify technical data without prior notice. Your Endress+Hauser Sales Center will supply you with current information and updates to these Instructions.

## Table of contents

<b>1</b>	<b>Document information</b>	<b>6</b>		
1.1	Document function	6		
1.2	Symbols used	6		
1.2.1	Safety symbols	6		
1.2.2	Electrical symbols	6		
1.2.3	Tool symbols	6		
1.2.4	Symbols for certain types of information	7		
1.2.5	Symbols in graphics	7		
1.3	Documentation	7		
1.3.1	Standard documentation	8		
1.3.2	Supplementary device-dependent documentation	8		
1.4	Registered trademarks	8		
<b>2</b>	<b>Basic safety instructions</b>	<b>9</b>		
2.1	Requirements for the personnel	9		
2.2	Designated use	9		
2.3	Workplace safety	10		
2.4	Operational safety	10		
2.5	Product safety	10		
2.6	IT security	10		
<b>3</b>	<b>Product description</b>	<b>12</b>		
3.1	Product design	12		
3.1.1	Device version with PROFIBUS DP communication type	12		
<b>4</b>	<b>Incoming acceptance and product identification</b>	<b>13</b>		
4.1	Incoming acceptance	13		
4.2	Product identification	13		
4.2.1	Transmitter nameplate	14		
4.2.2	Sensor nameplate	15		
4.2.3	Symbols on measuring device	16		
<b>5</b>	<b>Storage and transport</b>	<b>17</b>		
5.1	Storage conditions	17		
5.2	Transporting the product	17		
5.2.1	Measuring devices without lifting lugs	17		
5.2.2	Measuring devices with lifting lugs	18		
5.2.3	Transporting with a fork lift	18		
5.3	Packaging disposal	18		
<b>6</b>	<b>Installation</b>	<b>19</b>		
6.1	Installation conditions	19		
6.1.1	Mounting position	19		
6.1.2	Requirements from environment and process	21		
6.1.3	Special mounting instructions	24		
6.2	Mounting the measuring device	26		
6.2.1	Required tools	26		
6.2.2	Preparing the measuring device	26		
6.2.3	Mounting the measuring device	26		
6.2.4	Turning the display module	26		
6.3	Post-installation check	27		
<b>7</b>	<b>Electrical connection</b>	<b>29</b>		
7.1	Connection conditions	29		
7.1.1	Required tools	29		
7.1.2	Requirements for connecting cable	29		
7.1.3	Terminal assignment	30		
7.1.4	Pin assignment, device plug	31		
7.1.5	Preparing the measuring device	31		
7.2	Connecting the measuring device	31		
7.2.1	Connecting the transmitter	32		
7.2.2	Ensuring potential equalization	33		
7.3	Special connection instructions	33		
7.3.1	Connection examples	33		
7.4	Hardware settings	34		
7.4.1	Setting the device address	34		
7.4.2	Enabling the terminating resistor	34		
7.5	Ensuring the degree of protection	35		
7.6	Post-connection check	36		
<b>8</b>	<b>Operation options</b>	<b>37</b>		
8.1	Overview of operation options	37		
8.2	Structure and function of the operating menu	38		
8.2.1	Structure of the operating menu	38		
8.2.2	Operating philosophy	39		
8.3	Access to the operating menu via the Web browser	39		
8.3.1	Function range	39		
8.3.2	Prerequisites	40		
8.3.3	Establishing a connection	40		
8.3.4	Logging on	41		
8.3.5	User interface	42		
8.3.6	Disabling the Web server	43		
8.3.7	Logging out	43		
8.4	Access to the operating menu via the operating tool	43		
8.4.1	Connecting the operating tool	43		
8.4.2	FieldCare	44		
<b>9</b>	<b>System integration</b>	<b>47</b>		
9.1	Overview of device description files	47		
9.1.1	Current version data for the device	47		
9.1.2	Operating tools	47		
9.2	Device master file (GSD)	47		
9.2.1	Manufacturer-specific GSD	47		
9.2.2	Profile GSD	48		
9.3	Cyclic data transmission	48		
9.3.1	Block model	48		

9.3.2	Description of the modules . . . . .	49	12.9	Event logbook . . . . .	89
			12.9.1	Event history . . . . .	89
			12.9.2	Filtering the event logbook . . . . .	90
			12.9.3	Overview of information events . . . . .	90
<b>10</b>	<b>Commissioning . . . . .</b>	<b>55</b>	12.10	Resetting the measuring device . . . . .	91
10.1	Function check . . . . .	55	12.10.1	Function scope of "Device reset" parameter . . . . .	92
10.2	Establishing a connection via FieldCare . . . . .	55	12.11	Device information . . . . .	92
10.3	Setting the operating language . . . . .	55	12.12	Firmware history . . . . .	93
10.4	Configuring the measuring device . . . . .	55	<b>13</b>	<b>Maintenance . . . . .</b>	<b>95</b>
10.4.1	Defining the tag name . . . . .	55	13.1	Maintenance tasks . . . . .	95
10.4.2	Setting the system units . . . . .	56	13.1.1	Exterior cleaning . . . . .	95
10.4.3	Selecting and setting the medium . . . . .	58	13.1.2	Interior cleaning . . . . .	95
10.4.4	Configuring the communication interface . . . . .	59	13.2	Measuring and test equipment . . . . .	95
10.4.5	Configuring the analog inputs . . . . .	59	13.3	Endress+Hauser services . . . . .	95
10.4.6	Configuring the low flow cut off . . . . .	61	<b>14</b>	<b>Repair . . . . .</b>	<b>96</b>
10.4.7	Configuring the partial filled pipe detection . . . . .	62	14.1	General notes . . . . .	96
10.5	Advanced settings . . . . .	63	14.2	Spare parts . . . . .	96
10.5.1	Calculated values . . . . .	63	14.3	Endress+Hauser services . . . . .	96
10.5.2	Carrying out a sensor adjustment . . . . .	64	14.4	Return . . . . .	96
10.5.3	Configuring the totalizer . . . . .	65	14.5	Disposal . . . . .	96
10.5.4	Carrying out additional display configurations . . . . .	67	14.5.1	Removing the measuring device . . . . .	96
10.6	Simulation . . . . .	70	14.5.2	Disposing of the measuring device . . . . .	97
10.7	Protecting settings from unauthorized access . . . . .	71	<b>15</b>	<b>Accessories . . . . .</b>	<b>98</b>
10.7.1	Write protection via access code . . . . .	71	15.1	Device-specific accessories . . . . .	98
10.7.2	Write protection via write protection switch . . . . .	72	15.1.1	For the sensor . . . . .	98
<b>11</b>	<b>Operation . . . . .</b>	<b>73</b>	15.2	Service-specific accessories . . . . .	98
11.1	Reading device locking status . . . . .	73	15.3	System components . . . . .	99
11.2	Adjusting the operating language . . . . .	73	<b>16</b>	<b>Technical data . . . . .</b>	<b>100</b>
11.3	Configuring the display . . . . .	73	16.1	Application . . . . .	100
11.4	Reading measured values . . . . .	73	16.2	Function and system design . . . . .	100
11.4.1	Process variables . . . . .	73	16.3	Input . . . . .	100
11.4.2	Totalizer . . . . .	74	16.4	Output . . . . .	102
11.4.3	Output values . . . . .	75	16.5	Power supply . . . . .	103
11.5	Adapting the measuring device to the process conditions . . . . .	76	16.6	Performance characteristics . . . . .	104
11.6	Performing a totalizer reset . . . . .	76	16.7	Installation . . . . .	108
<b>12</b>	<b>Diagnostics and troubleshooting . . . . .</b>	<b>77</b>	16.8	Environment . . . . .	108
12.1	General troubleshooting . . . . .	77	16.9	Process . . . . .	109
12.2	Diagnostic information via light emitting diodes . . . . .	78	16.10	Mechanical construction . . . . .	112
12.2.1	Transmitter . . . . .	78	16.11	Operability . . . . .	114
12.3	Diagnostic information on local display . . . . .	79	16.12	Certificates and approvals . . . . .	116
12.3.1	Diagnostic message . . . . .	79	16.13	Application packages . . . . .	117
12.3.2	Calling up remedial measures . . . . .	81	16.14	Accessories . . . . .	119
12.4	Diagnostic information in FieldCare . . . . .	81	16.15	Documentation . . . . .	119
12.4.1	Diagnostic options . . . . .	81	<b>17</b>	<b>Appendix . . . . .</b>	<b>121</b>
12.4.2	Calling up remedy information . . . . .	83	17.1	Overview of the operating menu . . . . .	121
12.5	Adapting the diagnostic information . . . . .	83	17.1.1	"Operation" menu . . . . .	121
12.5.1	Adapting the diagnostic behavior . . . . .	83	17.1.2	"Setup" menu . . . . .	122
12.6	Overview of diagnostic information . . . . .	85	17.1.3	"Diagnostics" menu . . . . .	126
12.7	Pending diagnostic events . . . . .	88	17.1.4	"Expert" menu . . . . .	130
12.8	Diagnostic list . . . . .	89			

**Index** ..... **147**





# 1 Document information

## 1.1 Document function







These Operating Instructions contain all the information that is required in various phases of the life cycle of the device: from product identification, incoming acceptance and storage, to mounting, connection, operation and commissioning through to troubleshooting, maintenance and disposal.

## 1.2 Symbols used



### 1.2.1 Safety symbols

Symbol	Meaning
	<b>DANGER!</b> This symbol alerts you to a dangerous situation. Failure to avoid this situation will result in serious or fatal injury.
	<b>WARNING!</b> This symbol alerts you to a dangerous situation. Failure to avoid this situation can result in serious or fatal injury.
	<b>CAUTION!</b> This symbol alerts you to a dangerous situation. Failure to avoid this situation can result in minor or medium injury.
	<b>NOTE!</b> This symbol contains information on procedures and other facts which do not result in personal injury.











### 1.2.2 Electrical symbols

Symbol	Meaning	Symbol	Meaning
	Direct current		Alternating current
	Direct current and alternating current		<b>Ground connection</b> A grounded terminal which, as far as the operator is concerned, is grounded via a grounding system.
	<b>Protective ground connection</b> A terminal which must be connected to ground prior to establishing any other connections.		<b>Equipotential connection</b> A connection that has to be connected to the plant grounding system: This may be a potential equalization line or a star grounding system depending on national or company codes of practice.





### 1.2.3 Tool symbols

Symbol	Meaning
	Allen key
	Open-ended wrench



### 1.2.4 Symbols for certain types of information

Symbol	Meaning
	<b>Permitted</b> Procedures, processes or actions that are permitted.
	<b>Preferred</b> Procedures, processes or actions that are preferred.
	<b>Forbidden</b> Procedures, processes or actions that are forbidden.
	<b>Tip</b> Indicates additional information.
	Reference to documentation
	Reference to page
	Reference to graphic
	Series of steps
	Result of a sequence of actions
	Help in the event of a problem
	Visual inspection

### 1.2.5 Symbols in graphics

Symbol	Meaning	Symbol	Meaning
1, 2, 3,...	Item numbers		Series of steps
A, B, C, ...	Views	A-A, B-B, C-C, ...	Sections
	Hazardous area		Safe area (non-hazardous area)
	Flow direction		

## 1.3 Documentation

-  For an overview of the scope of the associated Technical Documentation, refer to the following:
  - The CD-ROM provided for the device (depending on the device version, the CD-ROM might not be part of the delivery!)
  - The *W@M Device Viewer* : Enter the serial number from the nameplate ([www.endress.com/deviceviewer](http://www.endress.com/deviceviewer))
  - The *Endress+Hauser Operations App*: Enter the serial number from the nameplate or scan the 2-D matrix code (QR code) on the nameplate.
-  For a detailed list of the individual documents along with the documentation code

### 1.3.1 Standard documentation

Document type	Purpose and content of the document
Technical Information	<b>Planning aid for your device</b> The document contains all the technical data on the device and provides an overview of the accessories and other products that can be ordered for the device.
Brief Operating Instructions	<b>Guide that takes you quickly to the 1st measured value</b> The Brief Operating Instructions contain all the essential information from incoming acceptance to initial commissioning.

### 1.3.2 Supplementary device-dependent documentation

Additional documents are supplied depending on the device version ordered: Always comply strictly with the instructions in the supplementary documentation. The supplementary documentation is an integral part of the device documentation.

## 1.4 Registered trademarks

### **PROFIBUS®**

Registered trademark of the PROFIBUS User Organization, Karlsruhe, Germany

### **Microsoft®**

Registered trademark of the Microsoft Corporation, Redmond, Washington, USA

### **TRI-CLAMP®**

Registered trademark of Ladish & Co., Inc., Kenosha, USA

### **Applicator®, FieldCare®, Field Xpert™, HistoROM®, TMB®, Heartbeat Technology™**

Registered or registration-pending trademarks of the Endress+Hauser Group



## 2 Basic safety instructions

### 2.1 Requirements for the personnel

The personnel for installation, commissioning, diagnostics and maintenance must fulfill the following requirements:

- ▶ Trained, qualified specialists must have a relevant qualification for this specific function and task
- ▶ Are authorized by the plant owner/operator
- ▶ Are familiar with federal/national regulations
- ▶ Before beginning work, the specialist staff must have read and understood the instructions in the Operating Instructions and supplementary documentation as well as in the certificates (depending on the application)
- ▶ Following instructions and basic conditions

The operating personnel must fulfill the following requirements:

- ▶ Being instructed and authorized according to the requirements of the task by the facility's owner-operator
- ▶ Following the instructions in these Operating Instructions

### 2.2 Designated use

#### Application and media

The measuring device described in these Instructions is intended only for flow measurement of liquids and gases.

Depending on the version ordered, the measuring device can also measure potentially explosive, flammable, poisonous and oxidizing media.

Measuring devices for use in hazardous areas, in hygienic applications or in applications where there is an increased risk due to process pressure, are labeled accordingly on the nameplate.

To ensure that the measuring device remains in proper condition for the operation time:

- ▶ Only use the measuring device in full compliance with the data on the nameplate and the general conditions listed in the Operating Instructions and supplementary documentation.
- ▶ Based on the nameplate, check whether the ordered device is permitted for the intended use in the hazardous area (e.g. explosion protection, pressure vessel safety).
- ▶ Use the measuring device only for media against which the process-wetted materials are adequately resistant.
- ▶ If the measuring device is not operated at atmospheric temperature, compliance with the relevant basic conditions specified in the associated device documentation is absolutely essential: "Documentation" section (→  7).

#### Incorrect use

Non-designated use can compromise safety. The manufacturer is not liable for damage caused by improper or non-designated use.

#### **WARNING**

#### **Danger of breakage of the measuring tube due to corrosive or abrasive fluids.**

Housing breakage due to mechanical overload possible!

- ▶ Verify the compatibility of the process fluid with the measuring tube material.
- ▶ Ensure the resistance of all fluid-wetted materials in the process.
- ▶ Observe the specified pressure and temperature range.

Verification for borderline cases:

- ▶ For special fluids and fluids for cleaning, Endress+Hauser is glad to provide assistance in verifying the corrosion resistance of fluid-wetted materials, but does not accept any

warranty or liability as minute changes in the temperature, concentration or level of contamination in the process can alter the corrosion resistance properties.

#### **Residual risks**

The external surface temperature of the housing can increase by max. 20 K due to the power consumption of the electronic components. Hot process fluids passing through the measuring device will further increase the surface temperature of the housing. The surface of the sensor, in particular, can reach temperatures which are close to the fluid temperature.

Possible burn hazard due to fluid temperatures!

- ▶ For elevated fluid temperature, ensure protection against contact to prevent burns.

## **2.3 Workplace safety**

For work on and with the device:

- ▶ Wear the required personal protective equipment according to federal/national regulations.

For welding work on the piping:

- ▶ Do not ground the welding unit via the measuring device.

If working on and with the device with wet hands:

- ▶ It is recommended to wear gloves on account of the higher risk of electric shock.

## **2.4 Operational safety**

Risk of injury.

- ▶ Operate the device in proper technical condition and fail-safe condition only.
- ▶ The operator is responsible for interference-free operation of the device.

#### **Conversions to the device**

Unauthorized modifications to the device are not permitted and can lead to unforeseeable dangers.

- ▶ If, despite this, modifications are required, consult with Endress+Hauser.

#### **Repair**

To ensure continued operational safety and reliability,

- ▶ Carry out repairs on the device only if they are expressly permitted.
- ▶ Observe federal/national regulations pertaining to repair of an electrical device.
- ▶ Use original spare parts and accessories from Endress+Hauser only.

## **2.5 Product safety**

This measuring device is designed in accordance with good engineering practice to meet state-of-the-art safety requirements, has been tested, and left the factory in a condition in which it is safe to operate.

It meets general safety standards and legal requirements. It also complies with the EC directives listed in the device-specific EC Declaration of Conformity. Endress+Hauser confirms this by affixing the CE mark to the device.

## **2.6 IT security**

We only provide a warranty if the device is installed and used as described in the Operating Instructions. The device is equipped with security mechanisms to protect it against any inadvertent changes to the device settings.

IT security measures in line with operators' security standards and designed to provide additional protection for the device and device data transfer must be implemented by the operators themselves.

## 3 Product description

The device consists of a transmitter and a sensor.

One device version is available: compact version - transmitter and sensor form a mechanical unit.

### 3.1 Product design

#### 3.1.1 Device version with PROFIBUS DP communication type

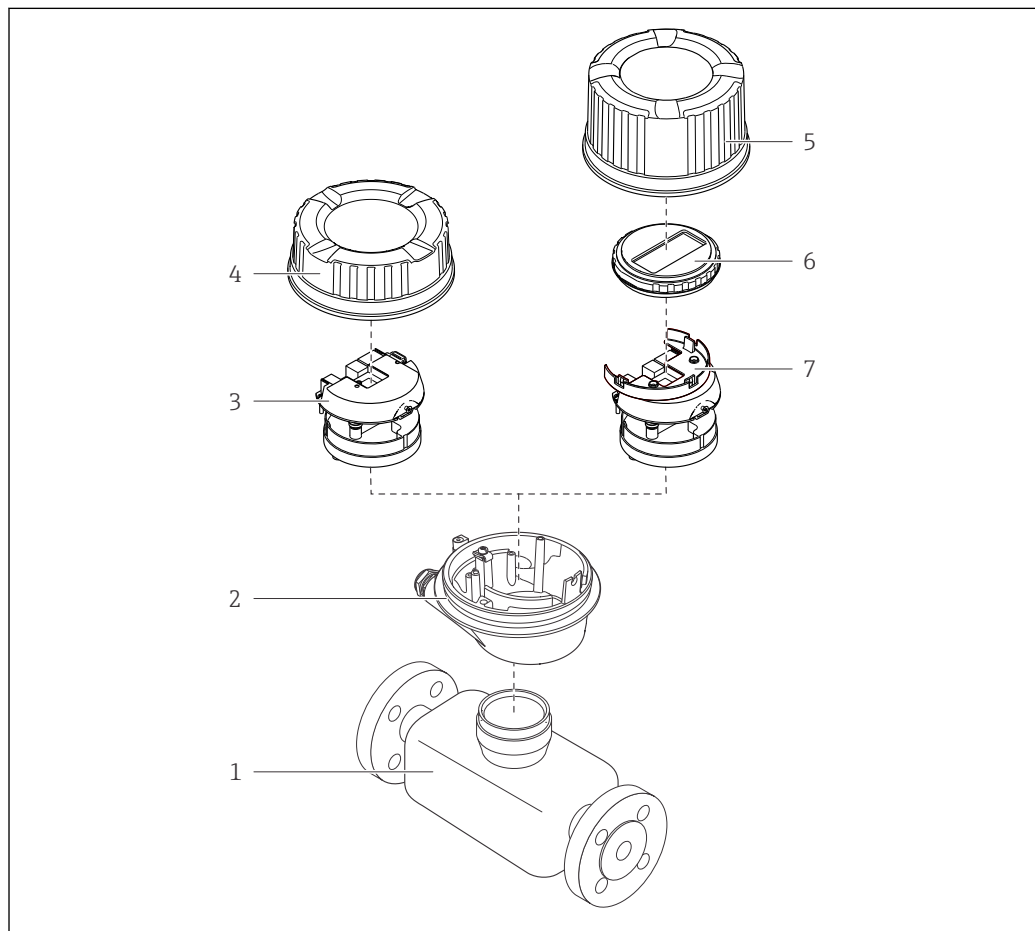

A0029153

#### 1 Important components of a measuring device

- 1 Sensor
- 2 Transmitter housing
- 3 Main electronics module
- 4 Transmitter housing cover
- 5 Transmitter housing cover (version for optional onsite display)
- 6 Onsite display (optional)
- 7 Main electronics module (with bracket for optional onsite display)

## 4 Incoming acceptance and product identification

### 4.1 Incoming acceptance

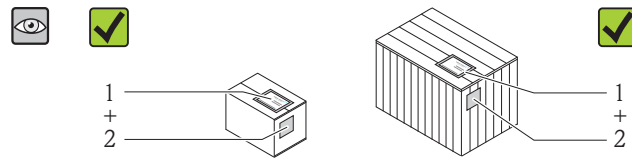

Are the order codes on the delivery note (1) and the product sticker (2) identical?

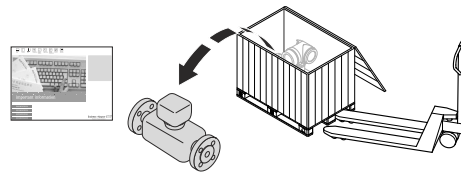

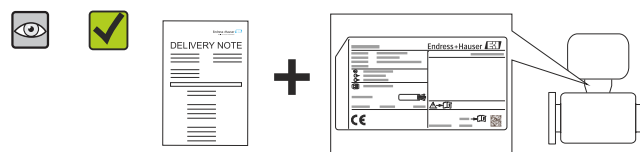

Are the goods undamaged?

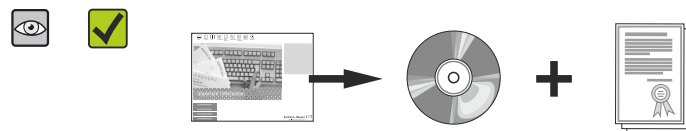

Do the nameplate data match the ordering information on the delivery note?



Is the CD-ROM with the Technical Documentation (depends on device version) and documents present?



-  If one of the conditions is not satisfied, contact your Endress+Hauser Sales Center.
- Depending on the device version, the CD-ROM might not be part of the delivery! The Technical Documentation is available via the Internet or via the *Endress+Hauser Operations App*, see the "Product identification" section (→  14).

### 4.2 Product identification

The following options are available for identification of the measuring device:

- Nameplate specifications
- Order code with breakdown of the device features on the delivery note
- Enter serial numbers from nameplates in *W@M Device Viewer* ([www.endress.com/deviceviewer](http://www.endress.com/deviceviewer)): All information about the measuring device is displayed.
- Enter the serial number from the nameplates into the *Endress+Hauser Operations App* or scan the 2-D matrix code (QR code) on the nameplate with the *Endress+Hauser Operations App*: all the information for the measuring device is displayed.

For an overview of the scope of the associated Technical Documentation, refer to the following:

- The chapters "Additional standard documentation on the device" (→  8) and "Supplementary device-dependent documentation" (→  8)
- The *W@M Device Viewer*: Enter the serial number from the nameplate ([www.endress.com/deviceviewer](http://www.endress.com/deviceviewer))
- The *Endress+Hauser Operations App*: Enter the serial number from the nameplate or scan the 2-D matrix code (QR code) on the nameplate.

#### 4.2.1 Transmitter nameplate

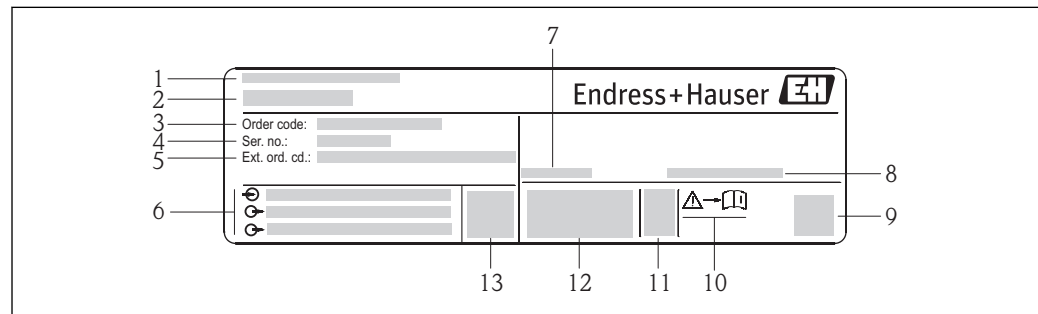

A0017520

 2 Example of a transmitter nameplate

- 1 Manufacturing location
- 2 Name of the transmitter
- 3 Order code
- 4 Serial number (Ser. no.)
- 5 Extended order code (Ext. ord. cd.)
- 6 Electrical connection data, e.g. available inputs and outputs, supply voltage
- 7 Permitted ambient temperature ( $T_a$ )
- 8 Degree of protection
- 9 2-D matrix code
- 10 Document number of safety-related supplementary documentation
- 11 Manufacturing date: year-month
- 12 CE mark, C-Tick
- 13 Firmware version (FW)

## 4.2.2 Sensor nameplate

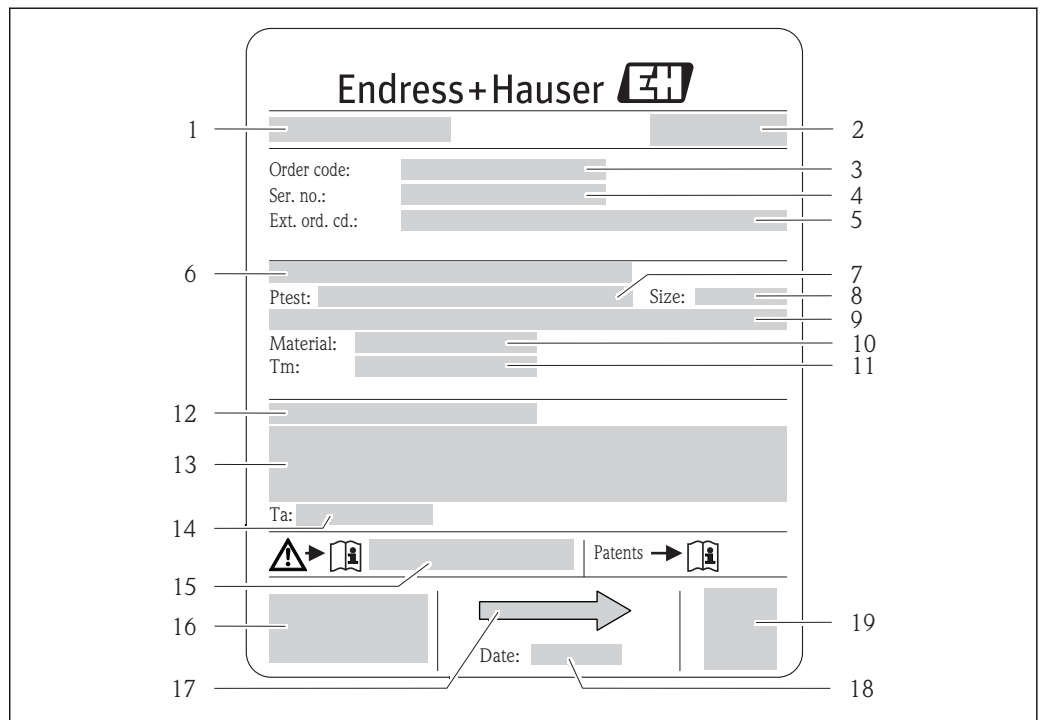

A0017923

 3 Example of a sensor nameplate

- 1 Name of the sensor
- 2 Manufacturing location
- 3 Order code
- 4 Serial number (ser. no.)
- 5 Extended order code (ext. ord. cd.)
- 6 Flange nominal diameter/nominal pressure
- 7 Test pressure of the sensor
- 8 Nominal diameter of sensor
- 9 Sensor-specific data: e.g. pressure range of secondary containment, wide-range density specification (special density calibration)
- 10 Material of measuring tube and manifold
- 11 Medium temperature range
- 12 Degree of protection
- 13 Approval information for explosion protection and Pressure Equipment Directive
- 14 Permitted ambient temperature ( $T_a$ )
- 15 Document number of safety-related supplementary documentation
- 16 CE mark, C-Tick
- 17 Flow direction
- 18 Manufacturing date: year-month
- 19 2-D matrix code



### Order code

The measuring device is reordered using the order code.

#### Extended order code

- The device type (product root) and basic specifications (mandatory features) are always listed.
- Of the optional specifications (optional features), only the safety and approval-related specifications are listed (e.g. LA). If other optional specifications are also ordered, these are indicated collectively using the # placeholder symbol (e.g. #LA#).
- If the ordered optional specifications do not include any safety and approval-related specifications, they are indicated by the + placeholder symbol (e.g. XXXXXX-ABCDE +).

### 4.2.3 Symbols on measuring device

Symbol	Meaning
	<b>WARNING!</b> This symbol alerts you to a dangerous situation. Failure to avoid this situation can result in serious or fatal injury.
	<b>Reference to documentation</b> Refers to the corresponding device documentation.
	<b>Protective ground connection</b> A terminal which must be connected to ground prior to establishing any other connections.



## 5 Storage and transport

### 5.1 Storage conditions

Observe the following notes for storage:

- Store in the original packaging to ensure protection from shock.
- Do not remove protective covers or protective caps installed on process connections. They prevent mechanical damage to the sealing surfaces and contamination in the measuring tube.
- Protect from direct sunlight to avoid unacceptably high surface temperatures.
- Storage temperature:  $-40$  to  $+80$  °C ( $-40$  to  $+176$  °F),  
Order Code "Test, Certificate", Option JM:  $-50$  to  $+60$  °C ( $-58$  to  $+140$  °F), preferably at  $+20$  °C ( $+68$  °F)
- Store in a dry and dust-free place.
- Do not store outdoors.

### 5.2 Transporting the product

Transport the measuring device to the measuring point in the original packaging.

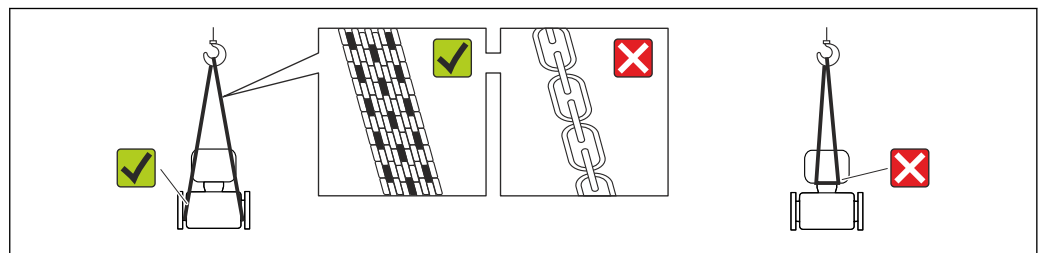

A0015604

- i** Do not remove protective covers or caps installed on process connections. They prevent mechanical damage to the sealing surfaces and contamination in the measuring tube.

#### 5.2.1 Measuring devices without lifting lugs

##### **⚠ WARNING**

**Center of gravity of the measuring device is higher than the suspension points of the webbing slings.**

Risk of injury if the measuring device slips.

- ▶ Secure the measuring device against slipping or turning.
- ▶ Observe the weight specified on the packaging (stick-on label).

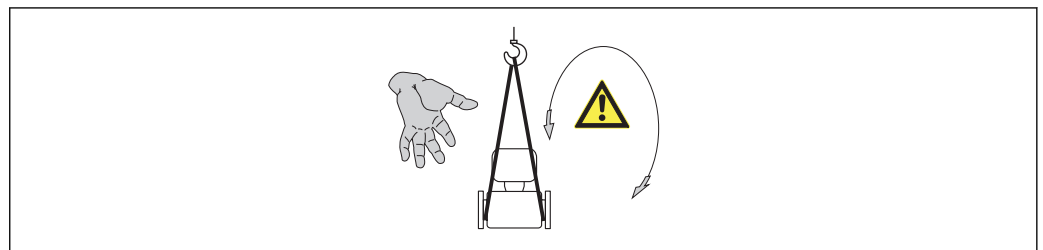

A0015606

## 5.2.2 Measuring devices with lifting lugs

### CAUTION

#### Special transportation instructions for devices with lifting lugs

- ▶ Only use the lifting lugs fitted on the device or flanges to transport the device.
- ▶ The device must always be secured at two lifting lugs at least.

## 5.2.3 Transporting with a fork lift

If transporting in wood crates, the floor structure enables the crates to be lifted lengthwise or at both sides using a forklift.

## 5.3 Packaging disposal

All packaging materials are environmentally friendly and 100% recyclable:

- Measuring device secondary packaging: polymer stretch film that conforms to EC Directive 2002/95/EC (RoHS).
- Packaging:
  - Wood crate, treated in accordance with ISPM 15 standard, which is confirmed by the affixed IPPC logo.
  - or
  - Carton in accordance with European Packaging Directive 94/62EC; recyclability is confirmed by the affixed RESY symbol.
- Seaworthy packaging (optional): Wood crate, treated in accordance with ISPM 15 standard, which is confirmed by the affixed IPPC logo.
- Carrying and mounting hardware:
  - Disposable plastic pallet
  - Plastic straps
  - Plastic adhesive strips
- Dunnage: Paper cushion

## 6 Installation

### 6.1 Installation conditions

No special measures such as supports are necessary. External forces are absorbed by the construction of the device.

#### 6.1.1 Mounting position

##### Mounting location

To prevent measuring errors arising from accumulation of gas bubbles in the measuring tube, avoid the following mounting locations in the pipe:

- Highest point of a pipeline.
- Directly upstream of a free pipe outlet in a down pipe.

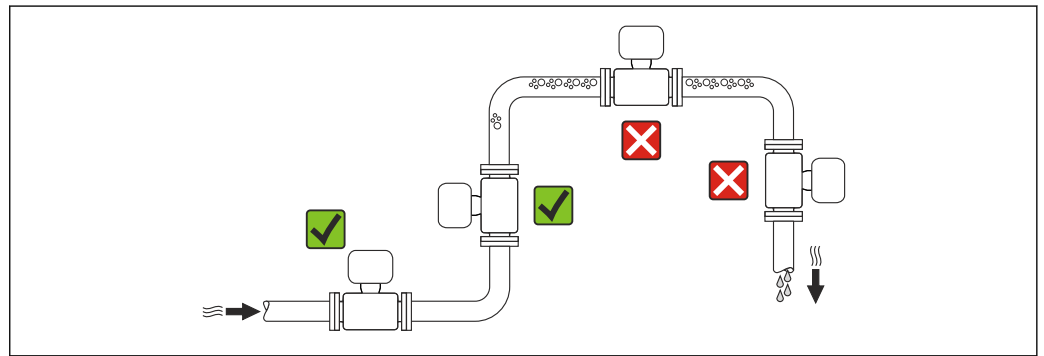

A0023344

##### Installation in down pipes

However, the following installation suggestion allows for installation in an open vertical pipeline. Pipe restrictions or the use of an orifice with a smaller cross-section than the nominal diameter prevent the sensor running empty while measurement is in progress.

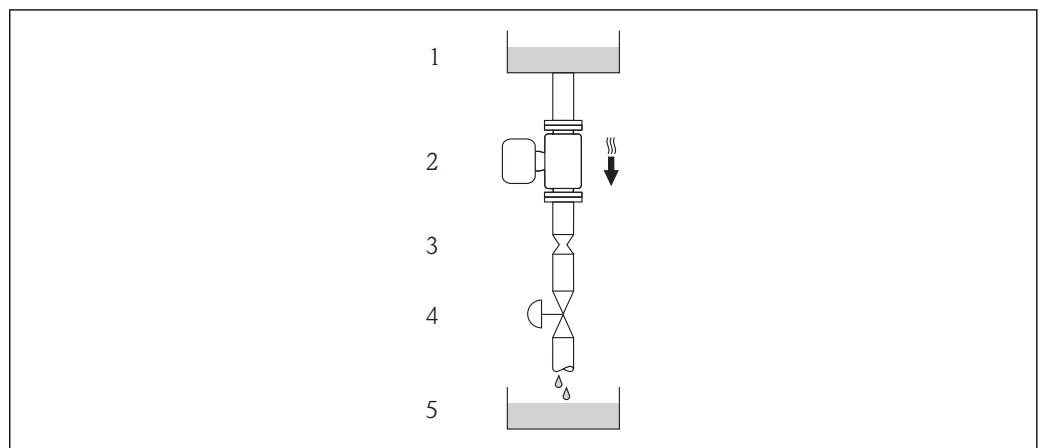

A0015596

4 Installation in a down pipe (e.g. for batching applications)



- 1 Supply tank
- 2 Sensor
- 3 Orifice plate, pipe restriction
- 4 Valve
- 5 Batching tank

DN		Ø orifice plate, pipe restriction	
[mm]	[in]	[mm]	[in]
8	3/8	6	0.24
15	1/2	10	0.40
15 FB	1/2 FB	15	0.60
25	1	14	0.55
25 FB	1 FB	24	0.95
40	1 1/2	22	0.87
40 FB	1 1/2 FB	35	1.38
50	2	28	1.10
50 FB	2 FB	54	2.13
80	3	50	1.97

FB = Full bore

**Orientation**

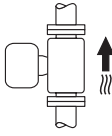
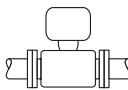
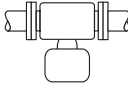
The direction of the arrow on the sensor nameplate helps you to install the sensor according to the flow direction (direction of medium flow through the piping).

Orientation			Recommendation
<b>A</b>	Vertical orientation	 A0015591	☑☑
<b>B</b>	Horizontal orientation, transmitter head up	 A0015589	☑☑ <sup>1)</sup> Exception:
<b>C</b>	Horizontal orientation, transmitter head down	 A0015590	☑☑ <sup>2)</sup> Exception:
<b>D</b>	Horizontal orientation, transmitter head at side	 A0015592	☑☑

- 1) Applications with low process temperatures may reduce the ambient temperature. To maintain the minimum ambient temperature for the transmitter, this orientation is recommended.
- 2) Applications with high process temperatures may increase the ambient temperature. To maintain the maximum ambient temperature for the transmitter, this orientation is recommended.

**Inlet and outlet runs**

No special precautions need to be taken for fittings which create turbulence, such as valves, elbows or T-pieces, as long as no cavitation occurs (→ 2.1).

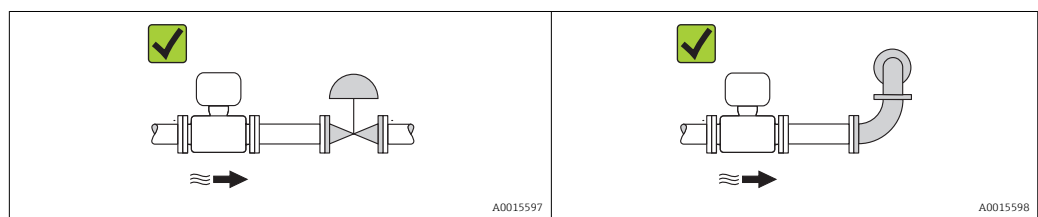

### Installation dimensions



For the dimensions and installation lengths of the device, see the "Technical Information" document, "Mechanical construction" section

## 6.1.2 Requirements from environment and process

### Ambient temperature range

Measuring device	Non-Ex	-40 to +60 °C (-40 to +140 °F)
	Ex na, NI version	-40 to +60 °C (-40 to +140 °F)
	Ex ia, IS version	<ul style="list-style-type: none"> <li>■ -40 to +60 °C (-40 to +140 °F)</li> <li>■ -50 to +60 °C (-58 to +140 °F) (Order code for "Test, certificate", option JM)</li> </ul>
Local display		-20 to +60 °C (-4 to +140 °F) The readability of the display may be impaired at temperatures outside the temperature range.

- ▶ If operating outdoors:  
Avoid direct sunlight, particularly in warm climatic regions.

### System pressure

It is important that cavitation does not occur, or that gases entrained in the liquids do not outgas.

Cavitation is caused if the pressure drops below the vapor pressure:

- In liquids that have a low boiling point (e.g. hydrocarbons, solvents, liquefied gases)
  - In suction lines
- ▶ Ensure the system pressure is sufficiently high to prevent cavitation and outgassing.

For this reason, the following mounting locations are recommended:

- At the lowest point in a vertical pipe
- Downstream from pumps (no danger of vacuum)

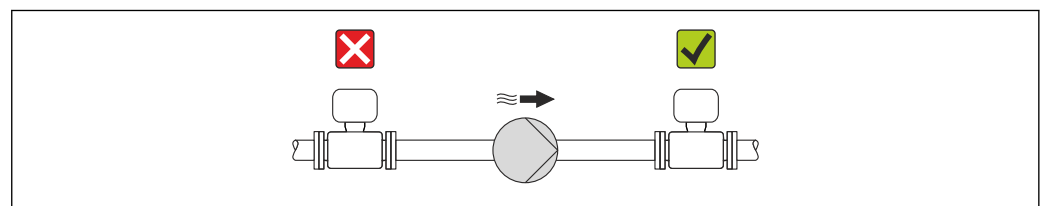

A0015594

### Thermal insulation

In the case of some fluids, it is important that the heat radiated from the sensor to the transmitter is kept to a minimum. A wide range of materials can be used for the required insulation.

#### NOTICE

#### Electronics overheating on account of thermal insulation!

- ▶ Observe maximum permitted insulation height of the transmitter neck so that the transmitter head is completely free.

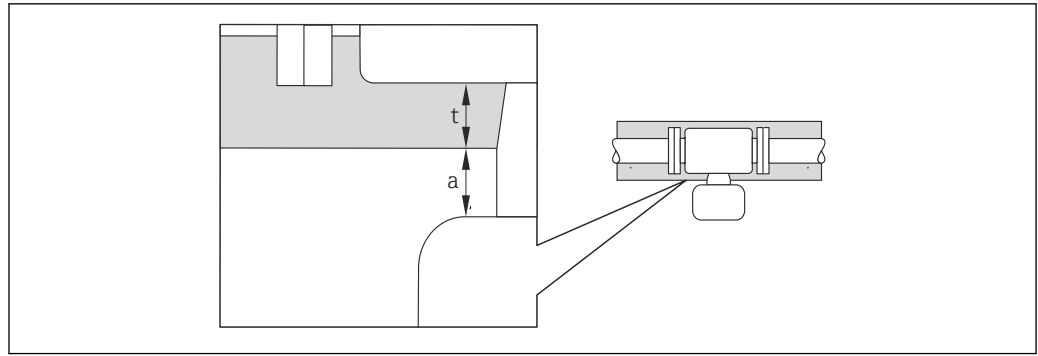

A0019919

- a Minimum distance to insulation
- t maximum Insulation thickness

The minimum distance between the transmitter housing and the insulation is 10 mm (0.39 in) so that the transmitter head remains completely exposed.

**Maximum recommended insulation thickness**

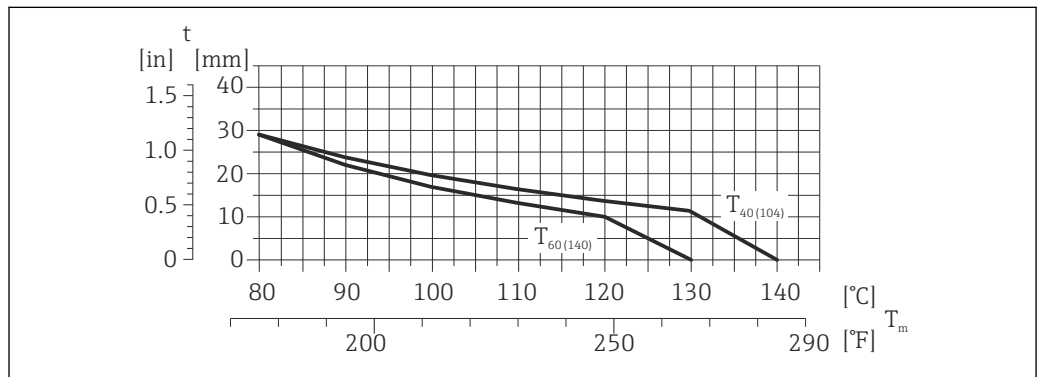

A0023173

5 Maximum recommended insulation thickness depending on the temperature of the medium and the ambient temperature

- t Insulation thickness
- T<sub>m</sub> Medium temperature
- T<sub>40(104)</sub> Maximum recommended insulation thickness at an ambient temperature of T<sub>a</sub> = 40 °C (104 °F)
- T<sub>60(140)</sub> Maximum recommended insulation thickness at an ambient temperature of T<sub>a</sub> = 60 °C (140 °F)

**Maximum recommended insulation thickness for the extended temperature range and insulation**

For the extension neck for insulation version, order code for "Sensor option", option CG:

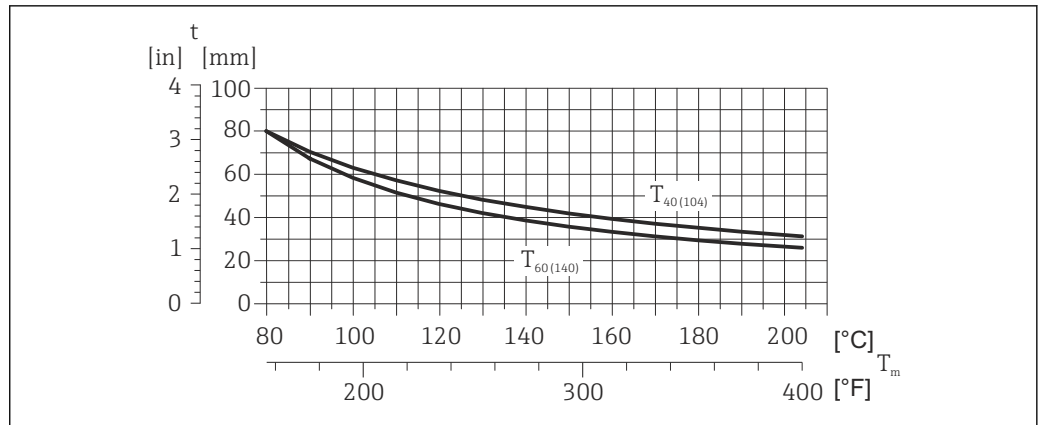

6 Maximum recommended insulation thickness depending on the temperature of the medium and the ambient temperature

$t$  Insulation thickness

$T_m$  Medium temperature

$T_{40(104)}$  Maximum recommended insulation thickness at an ambient temperature of  $T_a = 40\text{ °C}$  ( $104\text{ °F}$ )

$T_{60(140)}$  Maximum recommended insulation thickness at an ambient temperature of  $T_a = 60\text{ °C}$  ( $140\text{ °F}$ )

#### NOTICE

##### Danger of overheating with insulation

- ▶ Ensure that the temperature at the lower end of the transmitter housing does not exceed  $80\text{ °C}$  ( $176\text{ °F}$ )

#### NOTICE

##### The insulation can also be thicker than the maximum recommended insulation thickness.

Prerequisite:

- ▶ Ensure that convection takes place on a sufficiently large scale at the transmitter neck.
- ▶ Ensure that a sufficiently large area of the housing support remains exposed. The uncovered part serves as a radiator and protects the electronics from overheating and excessive cooling.

#### Heating

#### NOTICE

##### Electronics can overheat due to elevated ambient temperature!

- ▶ Observe maximum permitted ambient temperature for the transmitter ( $\rightarrow$  21).
- ▶ Depending on the fluid temperature, take the device orientation requirements into account.

#### NOTICE

##### Danger of overheating when heating

- ▶ Ensure that the temperature at the lower end of the transmitter housing does not exceed  $80\text{ °C}$  ( $176\text{ °F}$ )
- ▶ Ensure that convection takes place on a sufficiently large scale at the transmitter neck.
- ▶ Ensure that a sufficiently large area of the housing support remains exposed. The uncovered part serves as a radiator and protects the electronics from overheating and excessive cooling.

### Heating options

If a fluid requires that no heat loss should occur at the sensor, users can avail of the following heating options:

- Electrical heating, e.g. with electric band heaters
- Via pipes carrying hot water or steam
- Via heating jackets

### Using an electrical trace heating system

If heating is regulated via phase angle control or pulse packages, magnetic fields can affect the measured values (= for values that are greater than the values approved by the EN standard (sine 30 A/m)).

For this reason, the sensor must be magnetically shielded: the housing can be shielded with tin plates or electric sheets without a privileged direction (e.g. V330-35A).

The sheet must have the following properties:

- Relative magnetic permeability  $\mu_r \geq 300$
- Plate thickness  $d \geq 0.35$  mm ( $d \geq 0.014$  in)

### Vibrations

The high oscillation frequency of the measuring tubes ensures that the correct operation of the measuring system is not influenced by plant vibrations.

## 6.1.3 Special mounting instructions

### Guarantees complete drainability

When the sensor is installed in a horizontal line, eccentric clamps can be used to ensure complete drainability. When the system is pitched in a specific direction and at a specific slope, gravity can be used to achieve complete drainability. The sensor must be mounted in the correct position to ensure full drainability in the horizontal position. Markings on the sensor show the correct mounting position to optimize drainability.

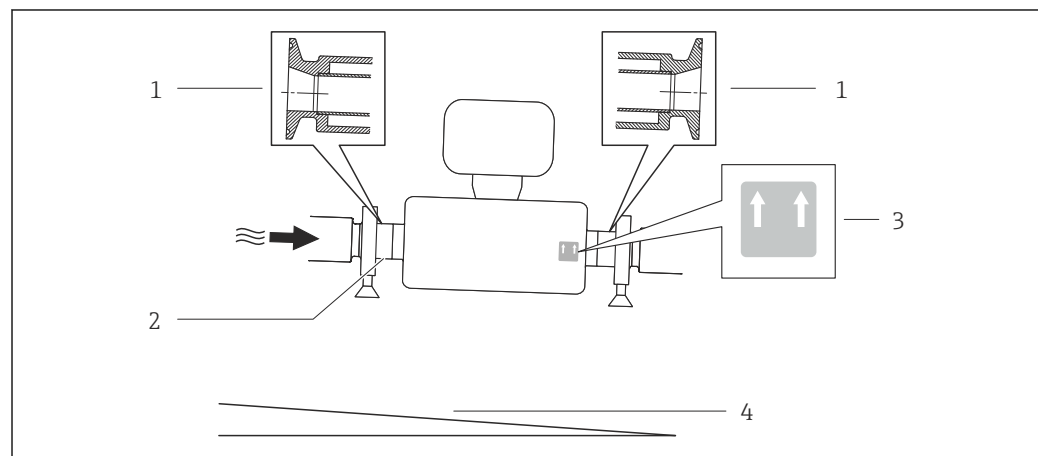

A0016585

#### 7

- 1 Eccentric clamp connection
- 2 Line on the underside indicates the lowest point of the eccentric process connection.
- 3 "This side up" label indicates which side is up
- 4 Slope the device in accordance with the hygiene guidelines. Slope: approx. 2 % or 21mm/m (0.24 in/feet)



### Securing with mounting clamp in the case of hygiene connections

It is not necessary to provide additional support for the sensor for operational performance purposes. If, however, additional support is required for installation purposes, the following dimensions must be observed.

Use mounting clamp with lining between clamp and measuring instrument.

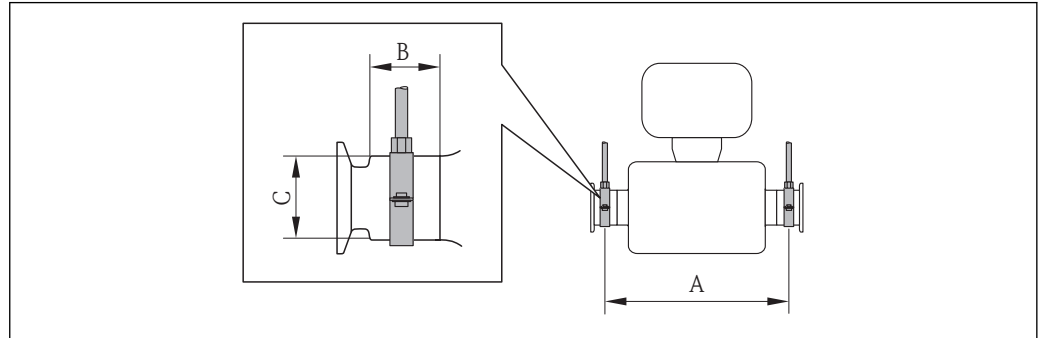

A0016588

#### SI units

DN [mm]	8	15	15 FB	25	25 FB	40	40 FB	50	50 FB	80
A [mm]	373	409	539	539	668	668	780	780	1 152	1 152
B [mm]	20	20	30	30	28	28	35	35	57	57
C [mm]	40	40	44.5	44.5	60	60	80	80	90	90

#### US units

DN [in]	$\frac{3}{8}$	$\frac{1}{2}$	$\frac{1}{2}$ FB	1	1 FB	1 $\frac{1}{2}$	1 $\frac{1}{2}$ FB	2	2 FB	3
A [in]	14.69	16.1	21.22	21.22	26.3	26.3	30.71	30.71	45.35	45.35
B [in]	0.79	0.79	1.18	1.18	1.1	1.1	1.38	1.38	2.24	2.24
C [in]	1.57	1.57	1.75	1.75	2.36	2.36	3.15	3.15	3.54	3.54

### Zero point adjustment

All measuring devices are calibrated in accordance with state-of-the-art technology. Calibration takes place under reference conditions ( $\rightarrow$  104). Therefore, a zero point adjustment in the field is generally not required.

Experience shows that zero point adjustment is advisable only in special cases:

- To achieve maximum measuring accuracy even with low flow rates
- Under extreme process or operating conditions (e.g. very high process temperatures or very high-viscosity fluids).

Zero point adjustment is performed via the **Zero point adjustment control** parameter ( $\rightarrow$  65).

## 6.2 Mounting the measuring device

### 6.2.1 Required tools

#### For sensor

For flanges and other process connections: Corresponding mounting tools

### 6.2.2 Preparing the measuring device

1. Remove all remaining transport packaging.
2. Remove any protective covers or protective caps present from the sensor.
3. Remove stick-on label on the electronics compartment cover.

### 6.2.3 Mounting the measuring device

#### **⚠ WARNING**

#### **Danger due to improper process sealing!**

- ▶ Ensure that the inside diameters of the gaskets are greater than or equal to that of the process connections and piping.
- ▶ Ensure that the gaskets are clean and undamaged.
- ▶ Install the gaskets correctly.

1. Ensure that the direction of the arrow on the nameplate of the sensor matches the flow direction of the fluid.
2. Install the measuring device or turn the transmitter housing so that the cable entries do not point upwards.

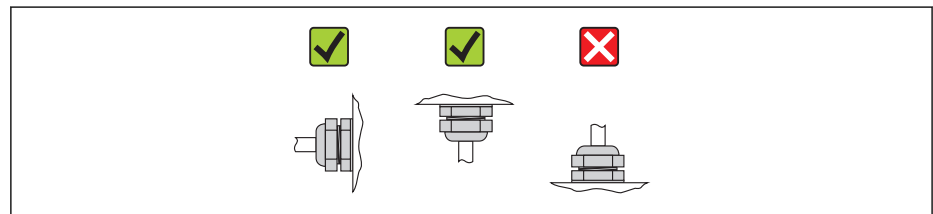

A0013964

### 6.2.4 Turning the display module

The local display is only available with the following device version:

Order code for "Display; Operation", option **B**: 4-line; lit, via communication

The display module can be turned to optimize display readability.

**Aluminum housing version, AlSi10Mg, coated**

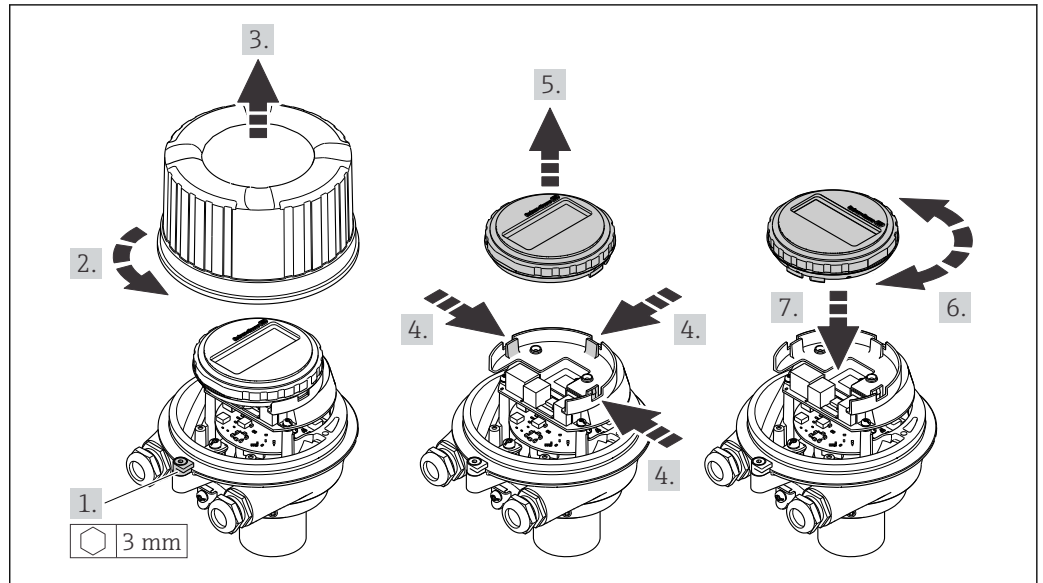

A0023192

**Compact and ultra-compact housing version, hygienic, stainless**

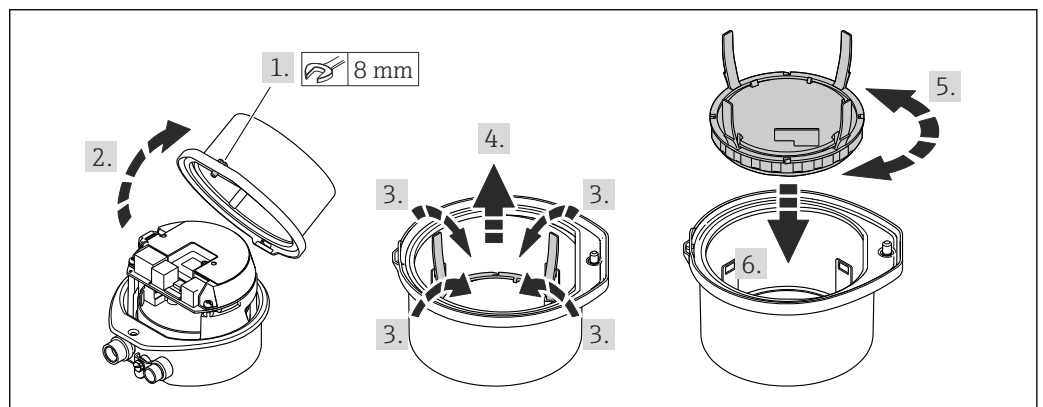

A0023195

**6.3 Post-installation check**

Is the device undamaged (visual inspection)?	<input type="checkbox"/>
Does the measuring device conform to the measuring point specifications? For example: <ul style="list-style-type: none"> <li>▪ Process temperature (→ 109)</li> <li>▪ Process pressure (refer to the chapter on "Pressure-temperature ratings" of the "Technical Information" document)</li> <li>▪ Ambient temperature (→ 21)</li> <li>▪ Measuring range (→ 100)</li> </ul>	<input type="checkbox"/>
Has the correct orientation for the sensor been selected ? <ul style="list-style-type: none"> <li>▪ According to sensor type</li> <li>▪ According to medium temperature</li> <li>▪ According to medium properties (outgassing, with entrained solids)</li> </ul>	<input type="checkbox"/>
Does the arrow on the sensor nameplate match the direction of flow of the fluid through the piping (→ 20)?	<input type="checkbox"/>
Are the measuring point identification and labeling correct (visual inspection)?	<input type="checkbox"/>

Is the device adequately protected from precipitation and direct sunlight?	<input type="checkbox"/>
Are the securing screw and securing clamp tightened securely?	<input type="checkbox"/>

## 7 Electrical connection

 The measuring device does not have an internal circuit breaker. For this reason, assign the measuring device a switch or power-circuit breaker so that the power supply line can be easily disconnected from the mains.

### 7.1 Connection conditions

#### 7.1.1 Required tools

- For cable entries: Use corresponding tools
- For securing clamp (on aluminum housing): Allen screw 3 mm
- For securing screw (for stainless steel housing): open-ended wrench 8 mm
- Wire stripper
- When using stranded cables: crimping tool for ferrule

#### 7.1.2 Requirements for connecting cable

The connecting cables provided by the customer must fulfill the following requirements.

##### Electrical safety

In accordance with applicable federal/national regulations.

##### Permitted temperature range

- $-40\text{ °C}$  ( $-40\text{ °F}$ ) to  $+80\text{ °C}$  ( $+176\text{ °F}$ )
- Minimum requirement: cable temperature range  $\geq$  ambient temperature  $+20\text{ K}$

##### Power supply cable

Standard installation cable is sufficient.

##### Signal cable

###### *PROFIBUS DP*

The IEC 61158 standard specifies two types of cable (A and B) for the bus line which can be used for every transmission rate. Cable type A is recommended.

<b>Cable type</b>	A
<b>Characteristic impedance</b>	135 to 165 $\Omega$ at a measuring frequency of 3 to 20 MHz
<b>Cable capacitance</b>	<30 pF/m
<b>Wire cross-section</b>	>0.34 mm <sup>2</sup> (22 AWG)
<b>Cable type</b>	Twisted pairs
<b>Loop resistance</b>	$\leq$ 110 $\Omega$ /km
<b>Signal damping</b>	Max. 9 dB over the entire length of the cable cross-section
<b>Shielding</b>	Copper braided shielding or braided shielding with foil shield. When grounding the cable shield, observe the grounding concept of the plant.

##### Cable diameter

- Cable glands supplied:  
M20  $\times$  1.5 with cable  $\phi$ 6 to 12 mm (0.24 to 0.47 in)
- Spring terminals:  
Wire cross-sections 0.5 to 2.5 mm<sup>2</sup> (20 to 14 AWG)

### 7.1.3 Terminal assignment



#### Transmitter

PROFIBUS DP connection version

 For use in the non-hazardous area and Zone 2/Div. 2.

Order code for "Output", option L

Depending on the housing version, the transmitters can be ordered with terminals or device plugs.

Order code for "Housing"	Connection methods available		Possible options for order code "Electrical connection"
	Output	Power supply	
Options A, B	Terminals	Terminals	<ul style="list-style-type: none"> <li>▪ Option A: coupling M20x1</li> <li>▪ Option B: thread M20x1</li> <li>▪ Option C: thread G ½"</li> <li>▪ Option D: thread NPT ½"</li> </ul>
Options A, B	Device plugs (→  31)	Terminals	<ul style="list-style-type: none"> <li>▪ Option L: plug M12x1 + thread NPT ½"</li> <li>▪ Option N: plug M12x1 + coupling M20</li> <li>▪ Option P: plug M12x1 + thread G ½"</li> <li>▪ Option U: plug M12x1 + thread M20</li> </ul>
Options A, B, C	Device plugs (→  31)	Device plugs (→  31)	Option Q: 2 x plug M12x1
Order code for "Housing": <ul style="list-style-type: none"> <li>▪ Option A: compact, coated aluminum</li> <li>▪ Option B: compact, hygienic, stainless</li> <li>▪ Option C: ultra-compact, hygienic, stainless</li> </ul>			

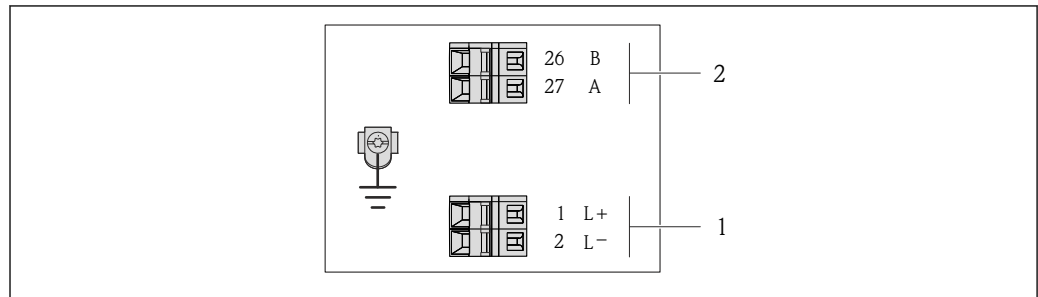

A0022716

 8 PROFIBUS DP terminal assignment

- 1 Power supply: DC 24 V
- 2 PROFIBUS DP

Order code for "Output"	Terminal number			
	Power supply		Output	
	2 (L-)	1 (L+)	26 (RxD/TxD-P)	27 (RxD/TxD-N)
Option L	DC 24 V		B	A
Order code for "Output": Option L: PROFIBUS DP, for use in non-hazardous areas and Zone 2/div. 2				

### 7.1.4 Pin assignment, device plug

#### PROFIBUS DP

 For use in the non-hazardous area and Zone 2/Div. 2.

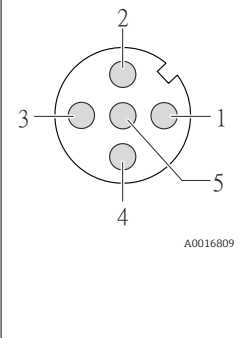

*Device plug for supply voltage (device side)*

	Pin		Assignment
	1	L+	DC 24 V
	2		
	3		
	4	L-	DC 24 V
	5		Grounding/shielding
Coding		Plug/socket	
A		Plug	

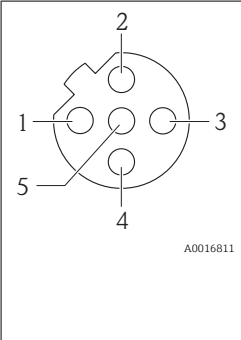
*Device plug for signal transmission (device side)*

	Pin		Assignment
	1		
	2	A	PROFIBUS DP
	3		
	4	B	PROFIBUS DP
	5		Grounding/shielding
Coding		Plug/socket	
B		Socket	

### 7.1.5 Preparing the measuring device

1. Remove dummy plug if present.
2. **NOTICE!** Insufficient sealing of the housing! Operational reliability of the measuring device could be compromised. Use suitable cable glands corresponding to the degree of protection.  
If measuring device is delivered without cable glands:  
Provide suitable cable gland for corresponding connecting cable (→  29).
3. If measuring device is delivered with cable glands:  
Observe cable specification (→  29).

## 7.2 Connecting the measuring device

### NOTICE

#### Limitation of electrical safety due to incorrect connection!

- ▶ Have electrical connection work carried out by correspondingly trained specialists only.
- ▶ Observe applicable federal/national installation codes and regulations.
- ▶ Comply with local workplace safety regulations.
- ▶ For use in potentially explosive atmospheres, observe the information in the device-specific Ex documentation.

### 7.2.1 Connecting the transmitter

The connection of the transmitter depends on the following order codes:

- Housing version: compact or ultra-compact
- Connection version: device plug or terminals

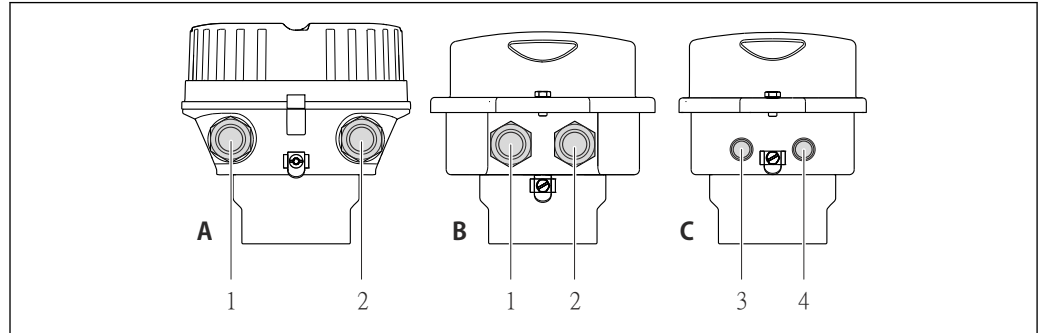

A0016924

9 Housing versions and connection versions

- A Housing version: compact, aluminum coated
- B Housing version: compact hygienic, stainless
- 1 Cable entry or device plug for signal transmission
- 2 Cable entry or device plug for supply voltage
- C Housing version: ultra-compact, hygienic, stainless:
- 3 Device plug for signal transmission
- 4 Device plug for supply voltage

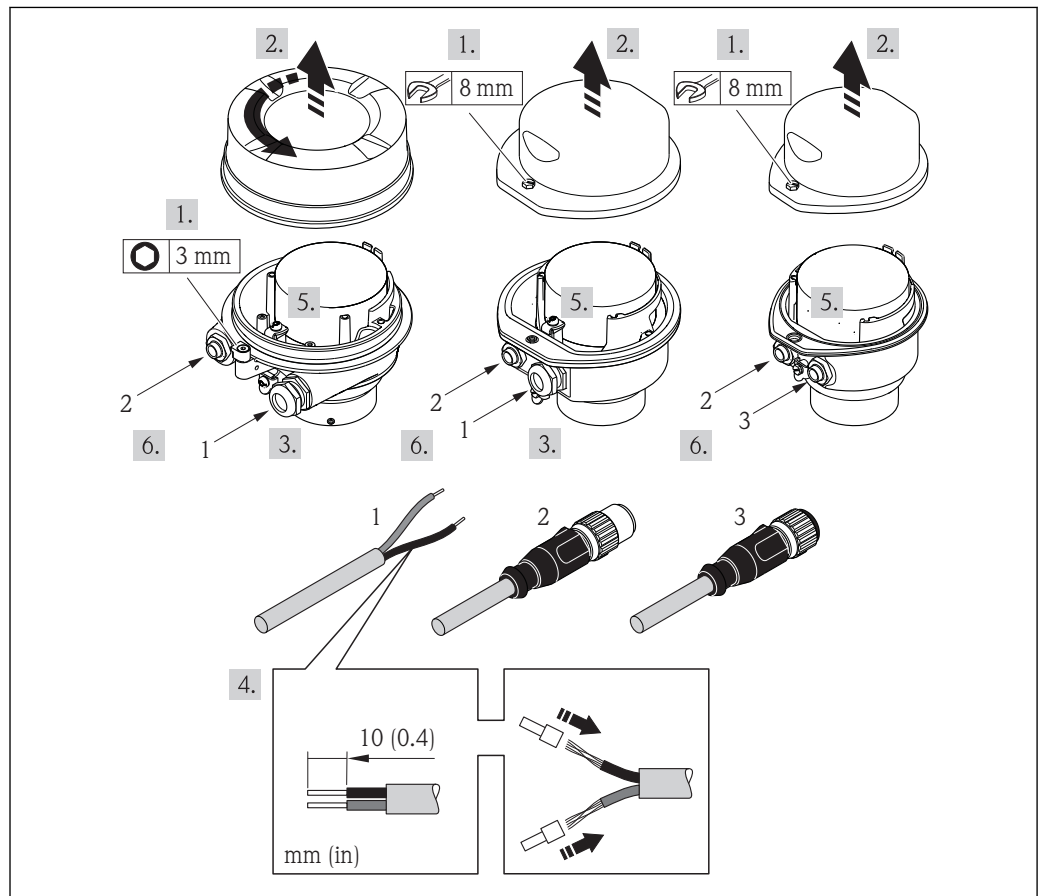

A0017844

10 Device versions with connection examples

- 1 Cable
- 2 Device plug for signal transmission
- 3 Device plug for supply voltage



For device version with device plug: follow step 6 only.

1. Depending on the housing version, loosen the securing clamp or fixing screw of the housing cover.
2. Depending on the housing version, unscrew or open the housing cover and disconnect the local display from the main electronics module where necessary (→ 115).
3. Push the cable through the cable entry . To ensure tight sealing, do not remove the sealing ring from the cable entry.
4. Strip the cable and cable ends. In the case of stranded cables, also fit ferrules.
5. Connect the cable in accordance with the terminal assignment or the device plug pin assignment .
6. Depending on the device version, tighten the cable glands or plug in the device plug and tighten .
7. **WARNING!** Housing degree of protection may be voided due to insufficient sealing of the housing. Screw in the screw without using any lubricant. The threads on the cover are coated with a dry lubricant.  
Reverse the removal procedure to reassemble the transmitter.

## 7.2.2 Ensuring potential equalization

### Requirements

No special measures for potential equalization are required.

 For devices intended for use in hazardous locations, please observe the guidelines in the Ex documentation (XA).

## 7.3 Special connection instructions

### 7.3.1 Connection examples

#### PROFIBUS DP

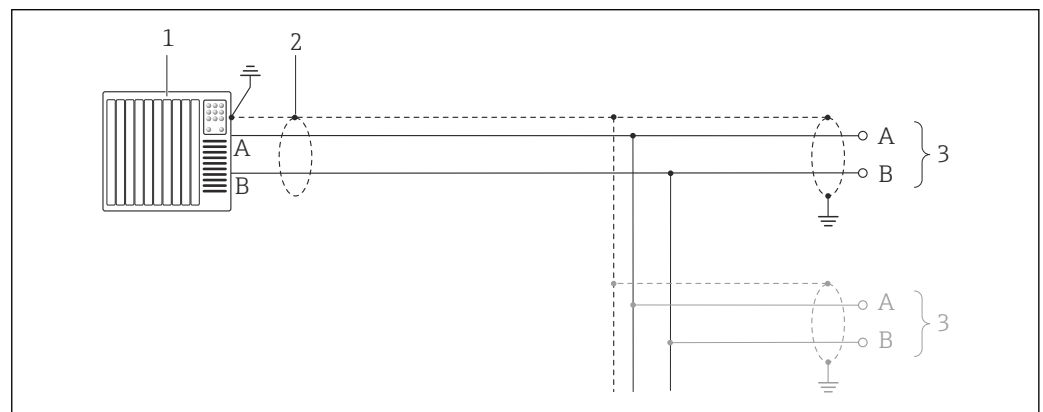

 11 Connection example for PROFIBUS DP, non-hazardous area and Zone 2/Div. 2

- 1 Control system (e.g. PLC)
- 2 Cable shield: the cable shield must be grounded at both ends to comply with EMC requirements; observe cable specifications (→ 29)
- 3 Transmitter

**i** If baud rates > 1.5 MBaud an EMC cable entry must be used and the cable shield must continue as far as the terminal wherever possible.

## 7.4 Hardware settings

### 7.4.1 Setting the device address

#### PROFIBUS DP

The address must always be configured for a PROFIBUS DP/PA device. The valid address range is between 1 and 126. In a PROFIBUS DP/PA network, each address can only be assigned once. If an address is not configured correctly, the device is not recognized by the master. All measuring devices are delivered from the factory with the device address 126 and with the software addressing method.

#### Setting the address

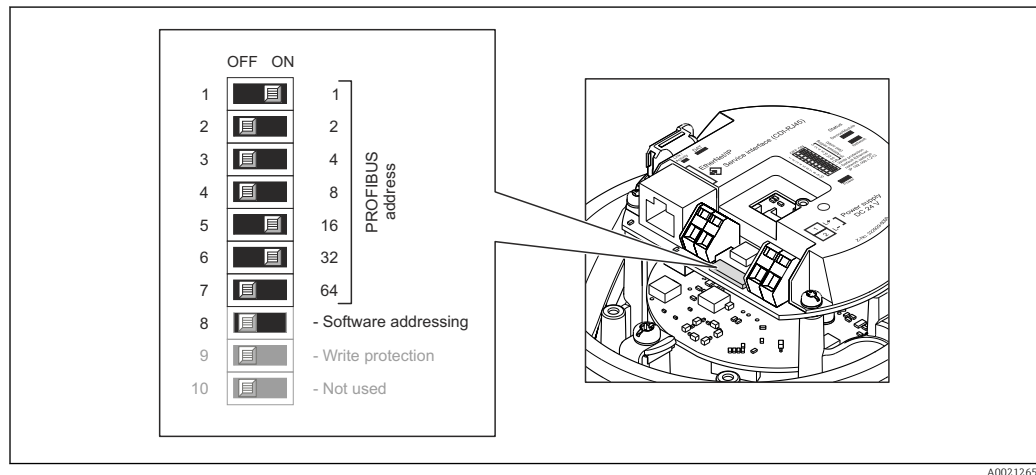

**12** Addressing using DIP switches on the I/O electronics module

1. Depending on the housing version, loosen the securing clamp or fixing screw of the housing cover.
2. Depending on the housing version, unscrew or open the housing cover and disconnect the local display from the main electronics module where necessary (→ **115**).
3. Disable software addressing via DIP switch 8 (OFF).
4. Set the desired device address via the corresponding DIP switches.
  - ↳ Example (→ **12**, **34**):  $1 + 16 + 32 =$  device address 49
  - The device demands rebooting after 10 s. After rebooting, hardware addressing is enabled with the configured IP address.
5. Reverse the removal procedure to reassemble the transmitter.

### 7.4.2 Enabling the terminating resistor

#### PROFIBUS DP

To avoid incorrect communication transmission caused by impedance mismatch, terminate the PROFIBUS DP cable correctly at the start and end of the bus segment.

- If the device is operated with a baud rate of 1.5 Mbaud and under:  
For the last transmitter on the bus, terminate via DIP switch 2 (bus termination) and DIP switch 1 and 3 (bus polarization). Setting: ON – ON – ON (→ ☑ 13, ☑ 35).
- For baud rates > 1.5 Mbaud:  
Due to the capacitance load of the user and the line reflections generated as a result, ensure that an external bus terminator is used.

**i** It is generally advisable to use an external bus terminator as the entire segment can fail if a device that is terminated internally is defective.

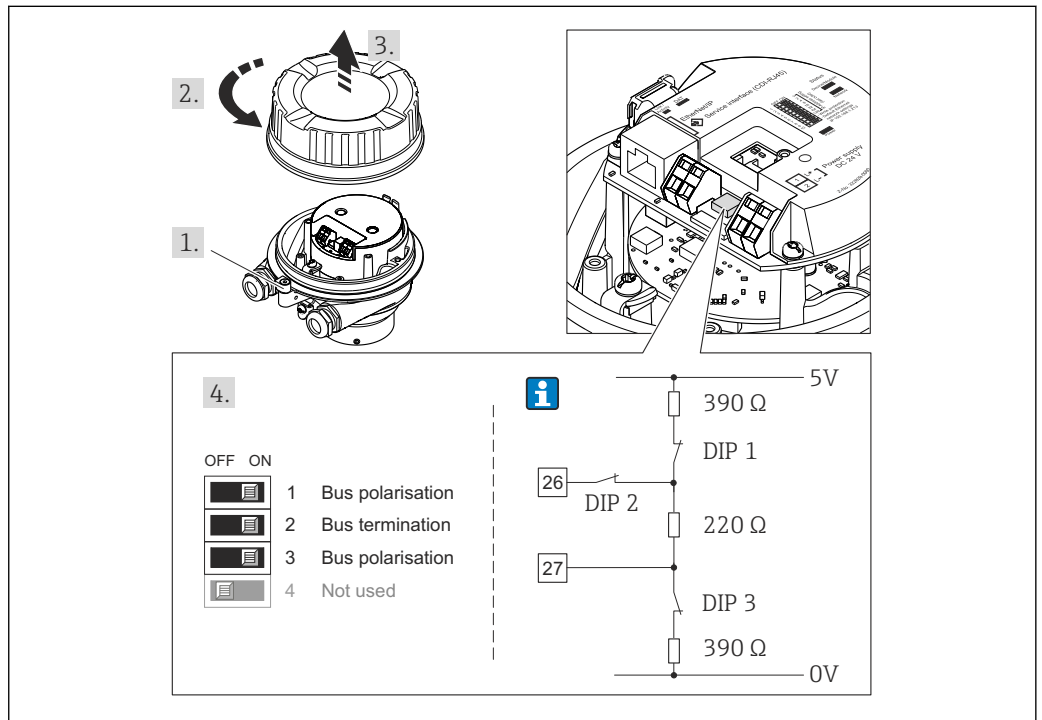

☑ 13 Termination using DIP switches on the I/O electronics module (for baud rates < 1.5 Mbaud)

### 7.5 Ensuring the degree of protection

The measuring device fulfills all the requirements for the IP66/67 degree of protection, Type 4X enclosure.

To guarantee IP66/67 degree of protection, Type 4X enclosure, carry out the following steps after the electrical connection:



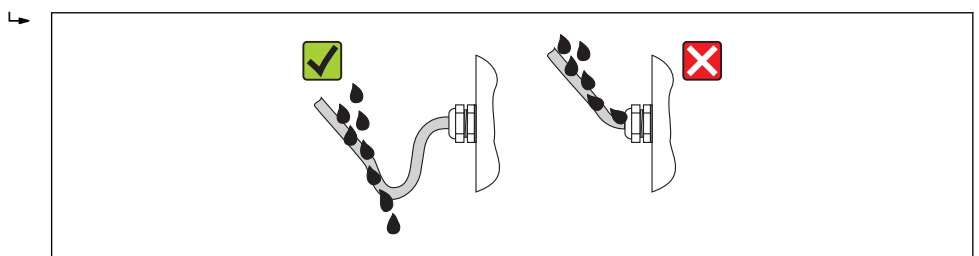

1. Check that the housing seals are clean and fitted correctly. Dry, clean or replace the seals if necessary.
2. Tighten all housing screws and screw covers.
3. Firmly tighten the cable glands.
4. To ensure that moisture does not enter the cable entry ("water trap").



A0013960

5. Insert dummy plugs into unused cable entries.

## 7.6 Post-connection check

Are cables or the device undamaged (visual inspection)?	<input type="checkbox"/>
Do the cables comply with the requirements (→  29)?	<input type="checkbox"/>
Do the cables have adequate strain relief?	<input type="checkbox"/>
Are all the cable glands installed, firmly tightened and leak-tight? Cable run with "water trap" (→  35) ?	<input type="checkbox"/>
Depending on the device version: are all the device plugs firmly tightened (→  32)?	<input type="checkbox"/>
Does the supply voltage match the specifications on the transmitter nameplate ?	<input type="checkbox"/>
Is the terminal assignment or the pin assignment of the device plug correct?	<input type="checkbox"/>
If supply voltage is present, is the power LED on the electronics module of the transmitter lit green (→  12)?	<input type="checkbox"/>
Depending on the device version, is the securing clamp or fixing screw firmly tightened?	<input type="checkbox"/>

## 8 Operation options

### 8.1 Overview of operation options

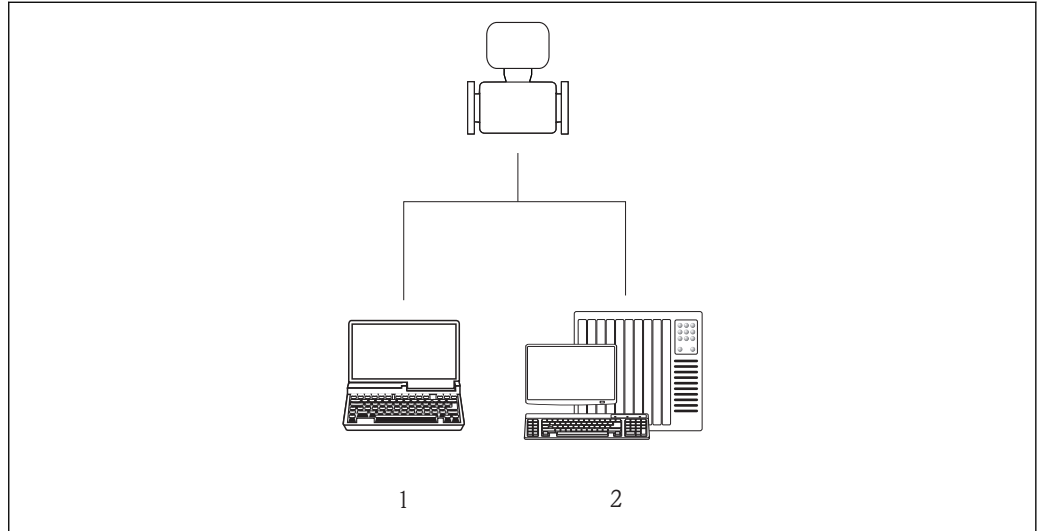

A0017760

- 1 Computer with Web browser (e.g. Internet Explorer) or with "FieldCare" operating tool
- 2 Automation system, e.g. "RSLogix" (Rockwell Automation) and work station for measuring device operation with Add-on Profile Level 3 for "RSLogix 5000" software (Rockwell Automation)

## 8.2 Structure and function of the operating menu

### 8.2.1 Structure of the operating menu

 For an overview of the operating menu with menus and parameters

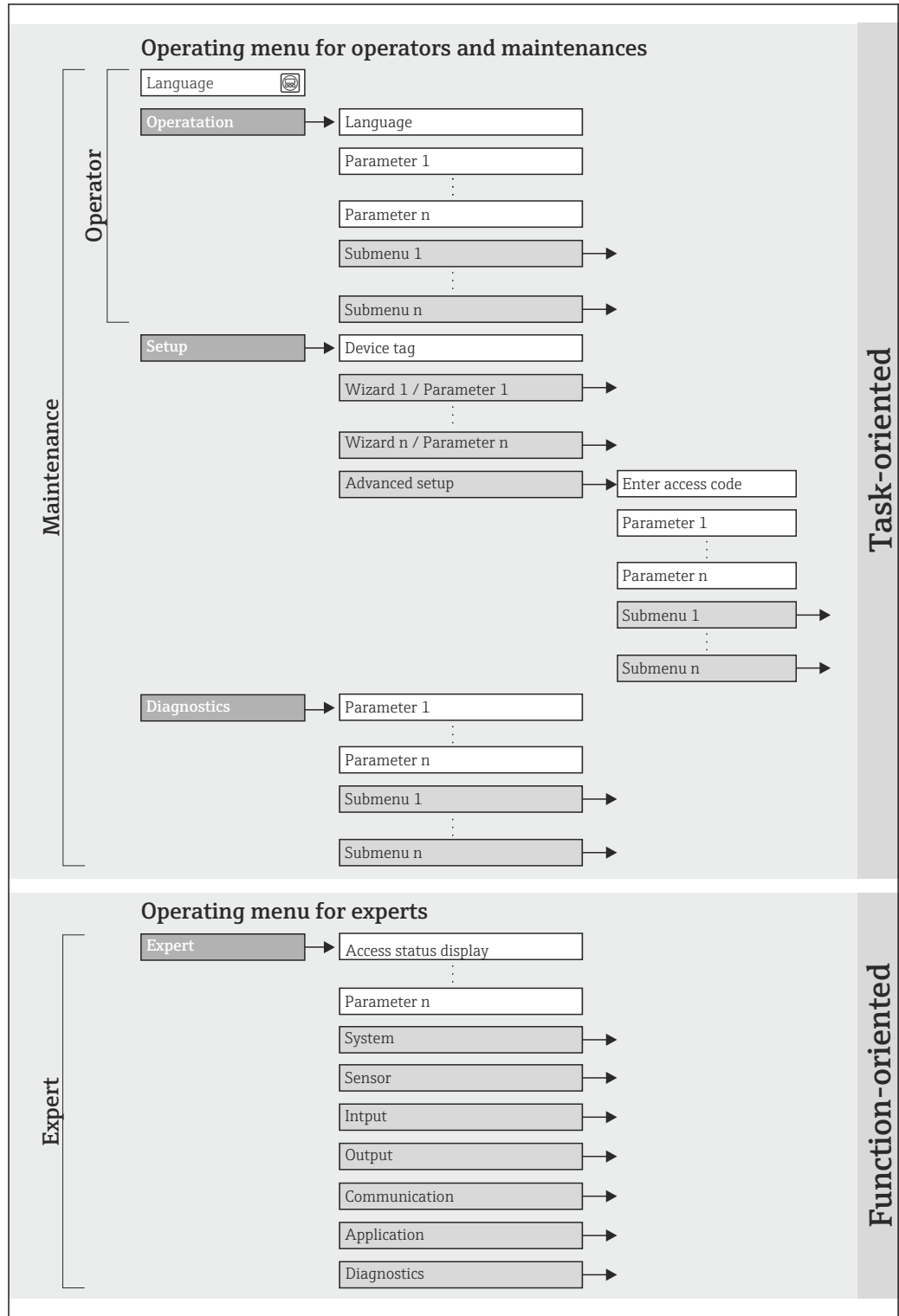

A0018237-EN

 14 Schematic structure of the operating menu

### 8.2.2 Operating philosophy

The individual parts of the operating menu are assigned to certain user roles (operator, maintenance etc.). Each user role contains typical tasks within the device lifecycle.

Menu		User role and tasks	Content/meaning
Language	task-oriented	<b>Role "Operator", "Maintenance"</b> Tasks during operation: <ul style="list-style-type: none"> <li>▪ Configuring the operational display</li> <li>▪ Reading measured values</li> </ul>	Defining the operating language
Operation			<ul style="list-style-type: none"> <li>▪ Configuring the operational display (e.g. display format, display contrast)</li> <li>▪ Resetting and controlling totalizers</li> </ul>
Setup		<b>"Maintenance" role</b> Commissioning: <ul style="list-style-type: none"> <li>▪ Configuration of the measurement</li> <li>▪ Configuration of the inputs and outputs</li> </ul>	<b>"Advanced setup" submenu:</b> <ul style="list-style-type: none"> <li>▪ For more customized configuration of the measurement (adaptation to special measuring conditions)</li> <li>▪ Configuration of totalizers</li> <li>▪ Administration (define access code, reset measuring device)</li> </ul>
Diagnostics		<b>"Maintenance" role</b> Fault elimination: <ul style="list-style-type: none"> <li>▪ Diagnostics and elimination of process and device errors</li> <li>▪ Measured value simulation</li> </ul>	Contains all parameters for error detection and analyzing process and device errors: <ul style="list-style-type: none"> <li>▪ <b>"Diagnostic list" submenu</b> Contains up to 5 currently pending diagnostic messages.</li> <li>▪ <b>"Event logbook" submenu</b> Contains up to 20 or 100 (order option "Extended HistoROM") event messages that have occurred.</li> <li>▪ <b>"Device information" submenu</b> Contains information for identifying the device.</li> <li>▪ <b>"Measured values" submenu</b> Contains all current measured values.</li> <li>▪ <b>"Heartbeat Technology" submenu</b> The functionality of the device is checked on demand and the verification results are documented.</li> <li>▪ <b>"Simulation" submenu</b> Is used to simulate measured values or output values.</li> </ul>
Expert	function-oriented	Tasks that require detailed knowledge of the function of the device: <ul style="list-style-type: none"> <li>▪ Commissioning measurements under difficult conditions</li> <li>▪ Optimal adaptation of the measurement to difficult conditions</li> <li>▪ Detailed configuration of the communication interface</li> <li>▪ Error diagnostics in difficult cases</li> </ul>	Contains all the parameters of the device and makes it possible to access these parameters directly using an access code. The structure of this menu is based on the function blocks of the device: <ul style="list-style-type: none"> <li>▪ <b>"System" submenu</b> Contains all higher-order device parameters that do not pertain either to measurement or the measured value communication.</li> <li>▪ <b>"Sensor" submenu</b> Configuration of the measurement.</li> <li>▪ <b>"Application" submenu</b> Configuration of the functions that go beyond the actual measurement (e.g. totalizer).</li> <li>▪ <b>"Diagnostics" submenu</b> Error detection and analysis of process and device errors and for device simulation and Heartbeat Technology.</li> </ul>

## 8.3 Access to the operating menu via the Web browser

### 8.3.1 Function range

Thanks to the integrated Web server the device can be operated and configured via a Web browser. In addition to the measured values, status information on the device is also displayed and allows the user to monitor the status of the device. Furthermore the device data can be managed and the network parameters can be configured.

### 8.3.2 Prerequisites



#### Computer hardware

Interface	The computer must have an RJ45 interface.
Connecting cable	Standard Ethernet cable with RJ45 connector.
Screen	Recommended size: $\geq 12"$ (depends on the screen resolution)  Web server operation is not optimized for touch screens!



#### Computer software

Recommended operating systems	Microsoft Windows 7 or higher.  Microsoft Windows XP is supported.
Web browsers supported	<ul style="list-style-type: none"> <li>▪ Microsoft Internet Explorer 8 or higher</li> <li>▪ Mozilla Firefox</li> <li>▪ Google chrome</li> </ul>

#### Computer settings

User rights	User rights are required for TCP/IP and proxy server settings (for changes to the IP address, subnet mask etc.).
Proxy server settings of the Web browser	The Web browser setting <i>Use proxy server for LAN</i> must be <b>disabled</b> .
JavaScript	JavaScript must be enabled.  If JavaScript cannot be enabled: enter <code>http://XXX.XXX.X.XXX/basic.html</code> in the address line of the Web browser, e.g. <code>http://192.168.1.212/basic.html</code> . A fully functional but simplified version of the operating menu structure starts in the Web browser.  When installing a new firmware version: To enable correct data display, clear the temporary memory (cache) of the Web browser under <b>Internet options</b> .

#### Measuring device

Web server	Web server must be enabled; factory setting: ON  For information on enabling the Web server (→  43)
------------	--

### 8.3.3 Establishing a connection

#### Configuring the Internet protocol of the computer

The following information refers to the default Ethernet settings of the device.

IP address of the device: 192.168.1.212 (factory setting)

IP address	192.168.1.XXX; for XXX all numerical values except: 0, 212 and 255 → e.g. 192.168.1.213
Subnet mask	255.255.255.0
Default gateway	192.168.1.212 or leave cells empty

1. Switch on the measuring device and connect to the computer via the cable (→  44).



2. If a 2nd network card is not used: all the applications on the notebook should be closed, or all the applications that require the Internet or network, such as e-mail, SAP applications, Internet or Windows Explorer, i.e. close all open Internet browsers.
3. Configure the properties of the Internet protocol (TCP/IP) as defined in the table above.

**Starting the Web browser**

1. Start the Web browser on the computer.
2. Enter the IP address of the Web server in the address line of the Web browser:  
192.168.1.212

The login page appears.

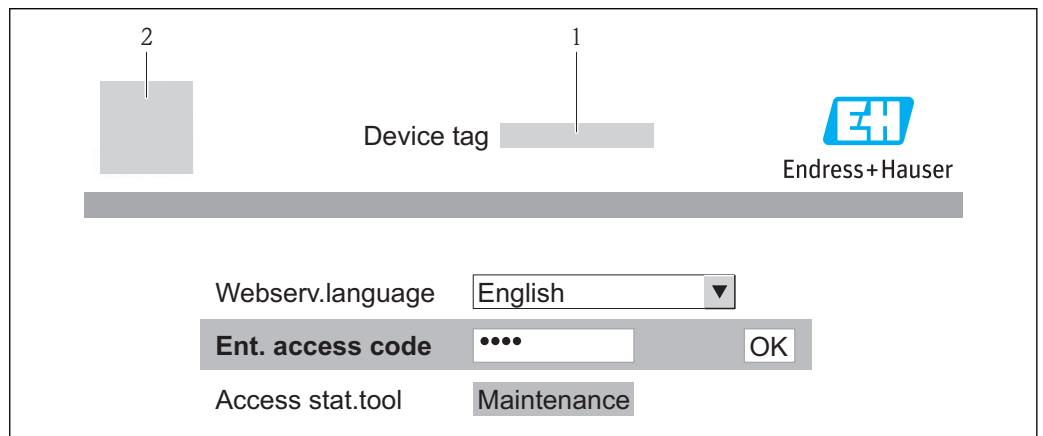

- 1 Device tag (→ 55)
- 2 Picture of device

**i** If a login page does not appear, or if the page is incomplete (→ 77)

**8.3.4 Logging on**

1. Select the preferred operating language for the Web browser.
2. Enter the access code.
3. Press **OK** to confirm your entry.

<b>Access code</b>	0000 (factory setting); can be changed by customer (→ 71)
--------------------	---

**i** If no action is performed for 10 minutes, the Web browser automatically returns to the login page.

### 8.3.5 User interface

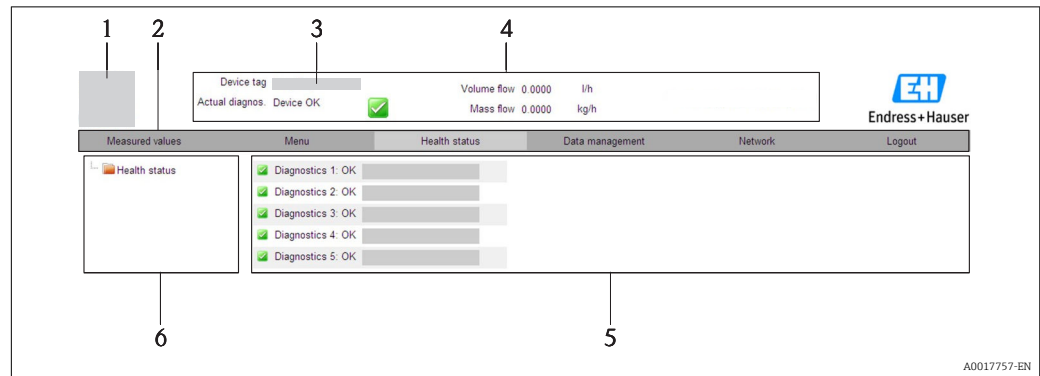

- 1 Picture of device
- 2 Function row with 6 functions
- 3 Device tag
- 4 Header
- 5 Working area
- 6 Navigation area

#### Header

The following information appears in the header:

- Device tag (→ 55)
- Device status with status signal (→ 82)
- Current measured values

#### Function row

Functions	Meaning
Measured values	The measured values of the device are displayed
Menu	Access to the operating menu structure of the device, same as for the operating tool
Device status	Displays the diagnostic messages currently pending, listed in order of priority
Data management	<ul style="list-style-type: none"> <li>■ Data exchange between PC and measuring device:                             <ul style="list-style-type: none"> <li>- Upload the configuration from the device (XML format, create configuration back-up)</li> <li>- Save the configuration to the device (XML format, restore configuration)</li> <li>- Export the event list (.csv file)</li> <li>- Export parameter settings (.csv file, create documentation of the measuring point configuration)</li> <li>- Export the Heartbeat verification log (PDF file, only available with the "Heartbeat Verification" application package)</li> </ul> </li> <li>■ Upload the device driver for system integration from the device</li> </ul>
Network configuration	Configuration and checking of all the parameters required for establishing the connection to the device: <ul style="list-style-type: none"> <li>■ Network settings (e.g. IP address, MAC address)</li> <li>■ Device information (e.g. serial number, firmware version)</li> </ul>
Logout	End the operation and call up the login page

#### Navigation area

If a function is selected in the function bar, the submenus of the function open in the navigation area. The user can now navigate through the menu structure.

**Working area**

Depending on the selected function and the related submenus, various actions can be performed in this area:

- Configuring parameters
- Reading measured values
- Calling up help text
- Starting an upload/download

**8.3.6 Disabling the Web server**

The Web server for the measuring device can be enabled and disabled as required via the **Web server functionality** parameter.

**Navigation**

"Expert" menu → Communication → Web server

**Parameter overview with brief description**

Parameter	Description	Selection	Factory setting
Web server functionality	Switch the Web server on and off.	<ul style="list-style-type: none"> <li>■ Off</li> <li>■ On</li> </ul>	On

**Enabling the Web server**

If the Web server is disabled it can only be re-enabled with the **Web server functionality** parameter via the following operating options:

Via "FieldCare" operating tool

**8.3.7 Logging out**

 Before logging out, perform a data backup via the **Data management** function (upload configuration from device) if necessary.

1. Select the **Logout** entry in the function row.  
↳ The home page with the Login box appears.
2. Close the Web browser.
3. Reset the modified properties of the Internet protocol (TCP/IP) if they are no longer needed (→  40).

**8.4 Access to the operating menu via the operating tool****8.4.1 Connecting the operating tool****Via PROFIBUS DP network**

This communication interface is available in device versions with PROFIBUS DP.

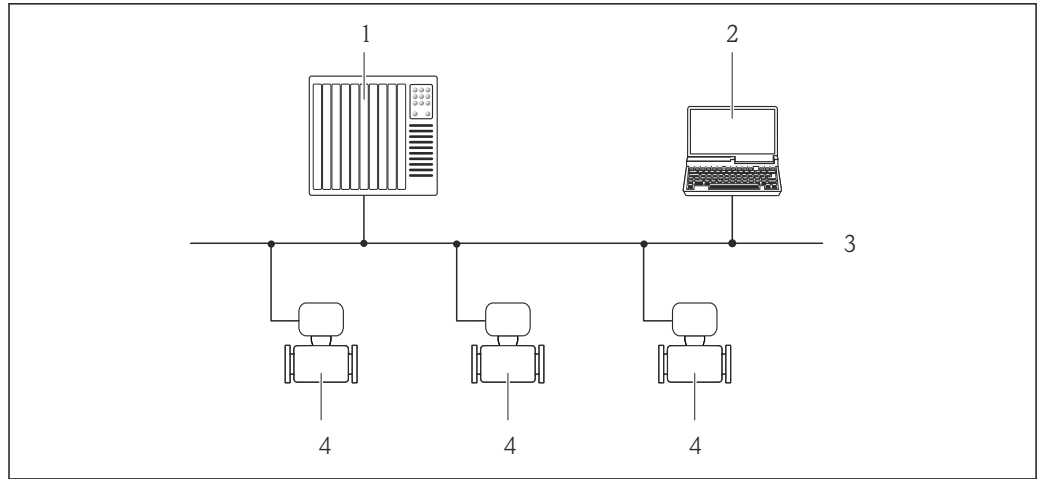

A0020905

15 Options for remote operation via PROFIBUS DP network

- 1 Automation system
- 2 Computer with PROFIBUS network card
- 3 PROFIBUS DP network
- 4 Measuring device

### Via service interface (CDI-RJ45)

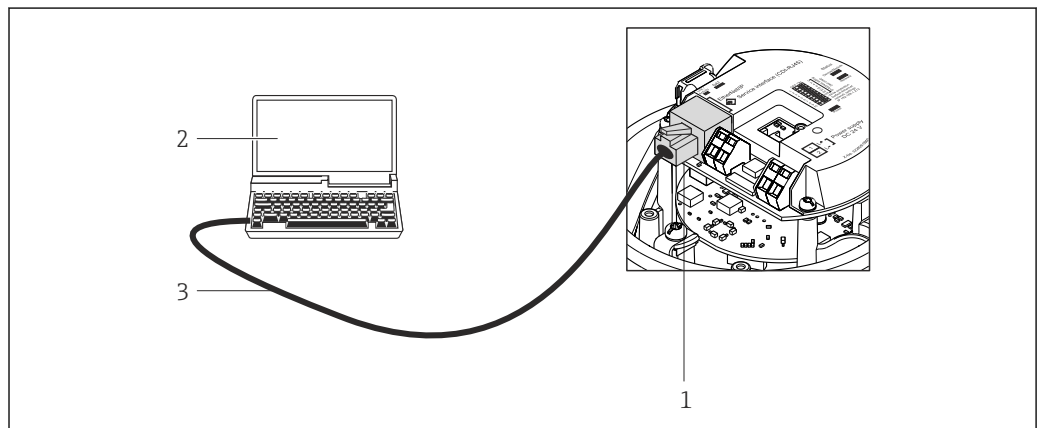

A0021270

16 Connection for order code for "Output", option L: PROFIBUS DP

- 1 Service interface (CDI -RJ45) of the measuring device with access to the integrated Web server
- 2 Computer with Web browser (e.g. Internet Explorer) for accessing the integrated device Web server or with "FieldCare" operating tool with COM DTM "CDI Communication TCP/IP"
- 3 Standard Ethernet connecting cable with RJ45 plug

## 8.4.2 FieldCare

### Function scope

FDT-based plant asset management tool from Endress+Hauser. It can configure all smart field devices in a system and helps you manage them. By using the status information, it is also a simple but effective way of checking their status and condition.

Access takes place via:

Service interface CDI-RJ45 (→ 44)

Typical functions:

- Configuring parameters of transmitters
- Loading and saving device data (upload/download)
- Documentation of the measuring point
- Visualization of the measured value memory (line recorder) and event logbook

 For details, see Operating Instructions BA00027S and BA00059S

### Source for device description files

See data (→  47)

### Establishing a connection

Via service interface (CDI-RJ45)

1. Start FieldCare and launch the project.
2. In the network: Add a device.
  - ↳ The **Add device** window opens.
3. Select the **CDI Communication TCP/IP** option from the list and press **OK** to confirm.
4. Right-click **CDI Communication TCP/IP** and select the **Add device** option in the context menu that opens.
5. Select the desired device from the list and press **OK** to confirm.
  - ↳ The **CDI Communication TCP/IP (Configuration)** window opens.
6. Enter the device address in the **IP address** field and press **Enter** to confirm: 192.168.1.212 (factory setting); if the IP address is not known .
7. Establish the online connection to the device.

 For details, see Operating Instructions BA00027S and BA00059S

User interface

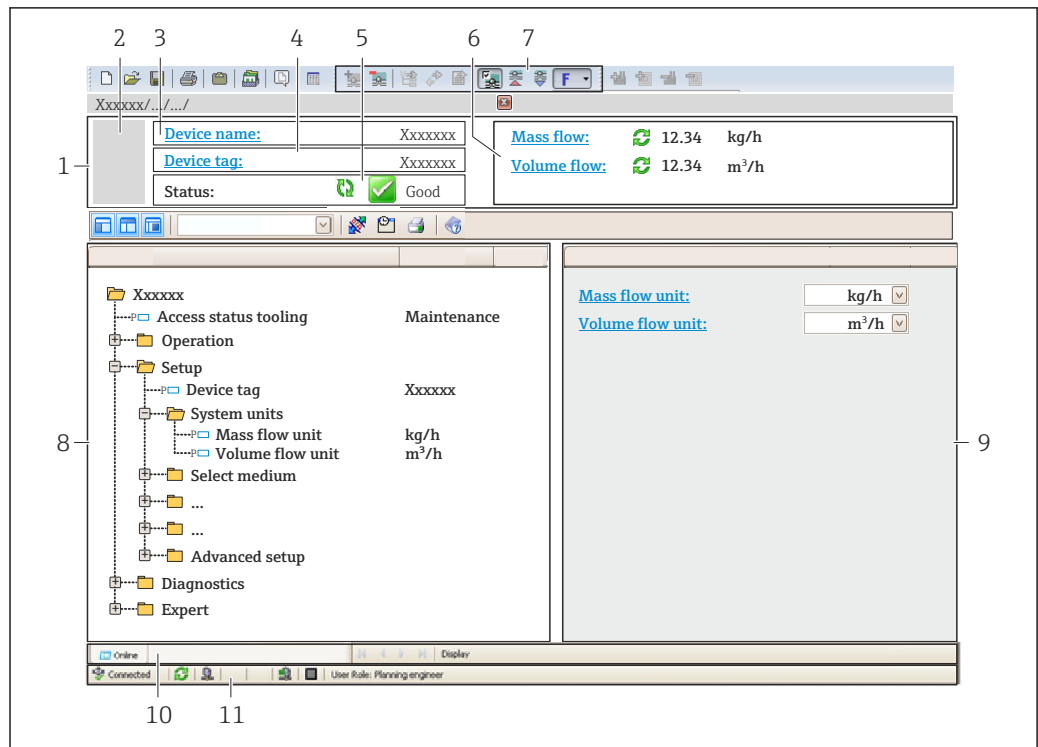

A0021051-EN

- 1 Header
- 2 Picture of device
- 3 Device name
- 4 Device tag (→ 55)
- 5 Status area with status signal (→ 82)
- 6 Display area for current measured values (→ 73)
- 7 Event list with additional functions such as save/load, events list and document creation
- 8 Navigation area with operating menu structure
- 9 Operating range
- 10 Range of action
- 11 Status area

## 9 System integration

### 9.1 Overview of device description files

#### 9.1.1 Current version data for the device

Firmware version	01.01.zz	<ul style="list-style-type: none"> <li>▪ On the title page of the Operating instructions</li> <li>▪ On transmitter nameplate (→  14)</li> <li>▪ Parameter <b>firmware version</b> Diagnostics → Device info → Firmware version</li> </ul>
Release date of firmware version	10.2014	---
Manufacturer ID	0x11	<b>Manufacturer ID</b> parameter Diagnostics → Device info → Manufacturer ID
Device type ID	0x1561	<b>Device type</b> parameter Diagnostics → Device info → Device type
Profile version	3.02	---

#### 9.1.2 Operating tools

Operating tool via PROFIBUS protocol	Sources for obtaining device descriptions
FieldCare	<ul style="list-style-type: none"> <li>▪ <a href="http://www.endress.com">www.endress.com</a> → Download Area</li> <li>▪ CD-ROM (contact Endress+Hauser)</li> <li>▪ DVD (contact Endress+Hauser)</li> </ul>

### 9.2 Device master file (GSD)

In order to integrate field devices into a bus system, the PROFIBUS system needs a description of the device parameters, such as output data, input data, data format, data volume and supported transmission rate.

These data are available in the device master file (GSD) which is provided to the PROFIBUS Master when the communication system is commissioned. In addition device bit maps, which appear as icons in the network structure, can also be integrated.

With the Profile 3.0 device master file (GSD) it is possible to exchange field devices made by different manufacturers without having to reconfigure.

Generally speaking two different GSD versions are possible with Profile 3.0 and higher.

-  ▪ Before configuring, the user must decide which GSD should be used to operate the system.
- The setting can be changed via a Class 2 master.

#### 9.2.1 Manufacturer-specific GSD

This GSD guarantees the unrestricted functionality of the measuring device. Device-specific process parameters and functions are therefore available.

Manufacturer-specific GSD	ID number	File name
PROFIBUS DP	0x1561	EH3x1561.gsd

The fact that the manufacturer-specific GSD should be used is specified in the **Ident number selector** parameter by selecting the **Manufacturer** option.

 Where to acquire the manufacturer-specific GSD:

[www.endress.com](http://www.endress.com) → Download Area

### 9.2.2 Profile GSD

Differs in terms of the number of Analog Input blocks (AI) and the measured values. If a system is configured with a Profile GSD, it is possible to exchange devices made by different manufacturers. However, it is essential to ensure that the order of the cyclic process values is correct.

ID number	Supported blocks	Supported channels
0x9740	<ul style="list-style-type: none"> <li>▪ 1 Analog Input</li> <li>▪ 1 Totalizer</li> </ul>	<ul style="list-style-type: none"> <li>▪ Channel Analog Input: volume flow</li> <li>▪ Channel totalizer: volume flow</li> </ul>
0x9741	<ul style="list-style-type: none"> <li>▪ 2 Analog Input</li> <li>▪ 1 Totalizer</li> </ul>	<ul style="list-style-type: none"> <li>▪ Channel Analog Input 1: volume flow</li> <li>▪ Channel Analog Input 2: mass flow</li> <li>▪ Channel totalizer: volume flow</li> </ul>
0x9742	<ul style="list-style-type: none"> <li>▪ 3 Analog Input</li> <li>▪ 1 Totalizer</li> </ul>	<ul style="list-style-type: none"> <li>▪ Channel Analog Input 1: volume flow</li> <li>▪ Channel Analog Input 2: mass flow</li> <li>▪ Channel Analog Input 3: corrected volume flow</li> <li>▪ Channel totalizer: volume flow</li> </ul>





The Profile GSD that is to be used is specified in the **Ident number selector** parameter by selecting the **Profile 0x9740** option, **Profile 0x9741** option or **Profile 0x9742** option.

## 9.3 Cyclic data transmission

Cyclic data transmission when using the device master file (GSD).

### 9.3.1 Block model

The block model shows which input and output data the measuring device makes available for cyclic data exchange. Cyclic data exchange takes place with a PROFIBUS master (Class 1), e.g. a control system etc.

Measuring device			Control system
<b>Transducer Block</b>	Analog Input block 1 to 8 (→  49)	Output value AI	→
		Output value TOTAL	→
	Totalizer block 1 to 3 (→  50)	Controller SETTOT	←
		Configuration MODETOT	←
	Analog Output block 1 to 3 (→  52)	Input values AO	←
	Discrete Input block 1 to 2 (→  53)	Output values DI	→
	Discrete Output block 1 to 3 (→  53)	Input values DO	←
			<b>PROFIBUS DP</b>

### Defined order of modules

The measuring device works as a modular PROFIBUS slave. In contrast to a compact slave, a modular slave has a variable design and consists of several individual modules. The device master file (GSD) contains a description of the individual modules (input and output data) along with their individual properties.



The modules are permanently assigned to the slots, i.e. when configuring the modules, the order and the arrangement of the modules must be respected.

Slot	Module	Function block
1 to 8	AI	Analog Input block 1 to 8
9	TOTAL or SETTOT_TOTAL or SETTOT_MODETOT_TOTAL	Totalizer block 1
10		Totalizer block 2
11		Totalizer block 3
12 to 14	AO	Analog Output block 1 to 3
15 to 16	DI	Discrete Input block 1 to 2
17 to 19	DO	Discrete Output block 1 to 3

To optimize the data throughput rate of the PROFIBUS network, it is advisable to only configure modules that are processed in the PROFIBUS master system. Any resulting gaps between the configured modules must be assigned to the EMPTY\_MODULE.

### 9.3.2 Description of the modules

-  The data structure is described from the perspective of the PROFIBUS master:
- Input data: Are sent from the measuring device to the PROFIBUS master.
  - Output data: Are sent from the PROFIBUS master to the measuring device.

#### AI module (Analog Input)

Transmit an input variable from the measuring device to the PROFIBUS master (Class 1).

The selected input variable, along with the status, is cyclically transmitted to the PROFIBUS master (Class 1) via the AI module. The input variable is depicted in the first four bytes in the form of a floating point number as per the IEEE 754 standard. The fifth byte contains standardized status information pertaining to the input variable.

Eight Analog Input blocks are available (slot 1 to 8).

*Selection: input variable*

The input variable can be specified using the CHANNEL parameter.

CHANNEL	Input variable
32961	Mass flow
33122	Volume flow
33093	Corrected volume flow
708	Flow velocity
32850	Density
33092	Reference density
33101	Temperature
1042	Electronics temperature
901	Target fluid mass flow <sup>1)</sup>
793	Carrier mass flow <sup>1)</sup>
794	Concentration <sup>1)</sup>
1039	Dynamic viscosity <sup>2)</sup>
1032	Kinematic viscosity <sup>2)</sup>
904	Temperature-compensated dynamic viscosity <sup>2)</sup>

CHANNEL	Input variable
905	Temperature-compensated kinematic viscosity <sup>2)</sup>
263	Carrier tube temperature <sup>3)</sup>

- 1) Only available with the "Concentration" application package
- 2) Only available with the "Viscosity" application package
- 3) Only available with the "Heartbeat Verification" application package

### Factory setting

Function block	Factory setting
AI 1	Mass flow
AI 2	Volume flow
AI 3	Corrected volume flow
AI 4	Density
AI 5	Reference density
AI 6	Temperature
AI 7	Off
AI 8	Off

### Data structure

#### Input data of Analog Input

Byte 1	Byte 2	Byte 3	Byte 4	Byte 5
Measured value: floating point number (IEEE 754)				Status

### TOTAL module

Transmit a totalizer value from the measuring device to the PROFIBUS master (Class 1).

Via the TOTAL module, a selected totalizer value along with the status is cyclically transmitted to a PROFIBUS master (Class 1). The totalizer value is depicted in the first four bytes in the form of a floating point number as per the IEEE 754 standard. The fifth byte contains standardized status information pertaining to the totalizer value.

Three totalizer blocks are available (slot 9 to 11).

#### Selection: totalizer value

The totalizer value can be specified using the CHANNEL parameter.

CHANNEL	Input variable
32961	Mass flow
33122	Volume flow
33093	Corrected volume flow
901	Target fluid mass flow <sup>1)</sup>
793	Carrier mass flow <sup>1)</sup>

- 1) Only available with the "Concentration" application package

*Factory setting*

Function block	Factory setting: TOTAL
Totalizer 1, 2 and 3	Mass flow

*Data structure*

*Input data of TOTAL*

Byte 1	Byte 2	Byte 3	Byte 4	Byte 5
Measured value: floating point number (IEEE 754)				Status

**SETTOT\_TOTAL module**

The module combination consists of the SETTOT and TOTAL functions:

- SETTOT: Control the totalizers via the PROFIBUS master.
- TOTAL: Transmit the totalizer value along with the status to the PROFIBUS master.

Three totalizer blocks are available (slot 9 to 11).

*Selection: control totalizer*

CHANNEL	Value SETTOT	Control totalizer
33310	0	Totalize
33046	1	Resetting
33308	2	Adopt totalizer initial setting

*Factory setting*

Function block	Factory setting: Value SETTOT (meaning)
Totalizer 1, 2 and 3	0 (totalizing)

*Data structure*

*Output data of SETTOT*

Byte 1
Control variable 1

*Input data of TOTAL*

Byte 1	Byte 2	Byte 3	Byte 4	Byte 5
Measured value: floating point number (IEEE 754)				Status

**SETTOT\_MODETOT\_TOTAL module**

The module combination consists of the SETTOT, MODETOT and TOTAL functions:

- SETTOT: Control the totalizers via the PROFIBUS master.
- MODETOT: Configure the totalizers via the PROFIBUS master.
- TOTAL: Transmit the totalizer value along with the status to the PROFIBUS master.

Three totalizer blocks are available (slot 9 to 11).

*Selection: totalizer configuration*

CHANNEL	MODETOT value	Totalizer configuration
33306	0	Balancing
33028	1	Balance the positive flow
32976	2	Balance the negative flow
32928	3	Stop totalizing

*Factory setting*

Function block	Factory setting: Value MODETOT (meaning)
Totalizer 1, 2 and 3	0 (balancing)

*Data structure**Output data of SETTOT and MODETOT*

Byte 1	Byte 2
Control variable 1: SETTOT	Control variable 2: MODETOT

*Input data of TOTAL*

Byte 1	Byte 2	Byte 3	Byte 4	Byte 5
Measured value: floating point number (IEEE 754)				Status

**AO module (Analog Output)**

Transmit a compensation value from the PROFIBUS master (Class 1) to the measuring device.

Via the AO module, a compensation value along with the status is cyclically transmitted from the PROFIBUS master (Class 1) to the measuring device. The compensation value is depicted in the first four bytes in the form of a floating point number as per the IEEE 754 standard. The fifth byte contains standardized status information pertaining to the compensation value.

Three Analog Output blocks are available (slot 12 to 14).

*Assigned compensation values*

A compensation value is permanently assigned to the individual Analog Output blocks.

CHANNEL	Function block	Compensation value
306	AO 1	External pressure <sup>1)</sup>
307	AO 2	External temperature <sup>1)</sup>
488	AO 3	External reference density

1) The compensation variables must be transmitted to the device in the SI basic unit



The selection is made via: "Expert" menu → Sensor → External compensation

*Data structure**Output data of Analog Output*

Byte 1	Byte 2	Byte 3	Byte 4	Byte 5
Measured value: floating point number (IEEE 754)				Status

**DI module (Discrete Input)**

Transmit discrete input values from the measuring device to the PROFIBUS master (Class 1). Discrete input values are used by the measuring device to transmit the state of device functions to the PROFIBUS master (Class 1).

The DI module cyclically transmits the discrete input value, along with the status, to the PROFIBUS master (Class 1). The discrete input value is depicted in the first byte. The second byte contains standardized status information pertaining to the input value.

Two Discrete Input blocks are available (slot 15 to 16).

*Selection: device function*

The device function can be specified using the CHANNEL parameter.

CHANNEL	Device function	Factory setting: state (meaning)
894	Empty pipe detection	<ul style="list-style-type: none"> <li>▪ 0 (device function not active)</li> <li>▪ 1 (device function active)</li> </ul>
895	Low flow cut off	
1430	Status verification <sup>1)</sup>	

1) Only available with the "Heartbeat Verification" application package

*Factory setting*

Function block	Factory setting
DI 1	Empty pipe detection
DI 2	Low flow cut off

*Data structure**Input data of Discrete Input*

Byte 1	Byte 2
Discrete	Status

**DO module (Discrete Output)**

Transmit discrete output values from the PROFIBUS master (Class 1) to the measuring device. Discrete output values are used by the PROFIBUS master (Class 1) to enable and disable device functions.

The DO module cyclically transmits the discrete output value, along with the status, to the measuring device. The discrete output value is depicted in the first byte. The second byte contains standardized status information pertaining to the output value.

Three Discrete Output blocks are available (slot 17 to 19).

*Assigned device functions*

A device function is permanently assigned to the individual Discrete Output blocks.

CHANNEL	Function block	Device function	Values: control (meaning)
891	DO 1	Flow override	<ul style="list-style-type: none"> <li>▪ 0 (disable device function)</li> <li>▪ 1 (enable device function)</li> </ul>
890	DO 2	Zero point adjustment	
1429	DO 3	Start verification <sup>1)</sup>	

1) Only available with the "Heartbeat Verification" application package

*Data structure**Output data of Discrete Output*

Byte 1	Byte 2
Discrete	Status



**EMPTY\_MODULE module**

This module is used to assign empty spaces arising from modules not being used in the slots (→  48).



## 10 Commissioning

### 10.1 Function check

Before commissioning the measuring device:

- ▶ Make sure that the post-installation and post-connection checks have been performed.
- "Post-installation check" checklist (→  27)
- "Post-connection check" checklist (→  36)

### 10.2 Establishing a connection via FieldCare

- For FieldCare connection (→  43)
- For establishing a connection via FieldCare (→  45)
- For FieldCare user interface (→  46)

### 10.3 Setting the operating language

Factory setting: English or ordered local language

The operating language of the local display can be set in FieldCare or via the Web server:  
"Operation" menu → Display language

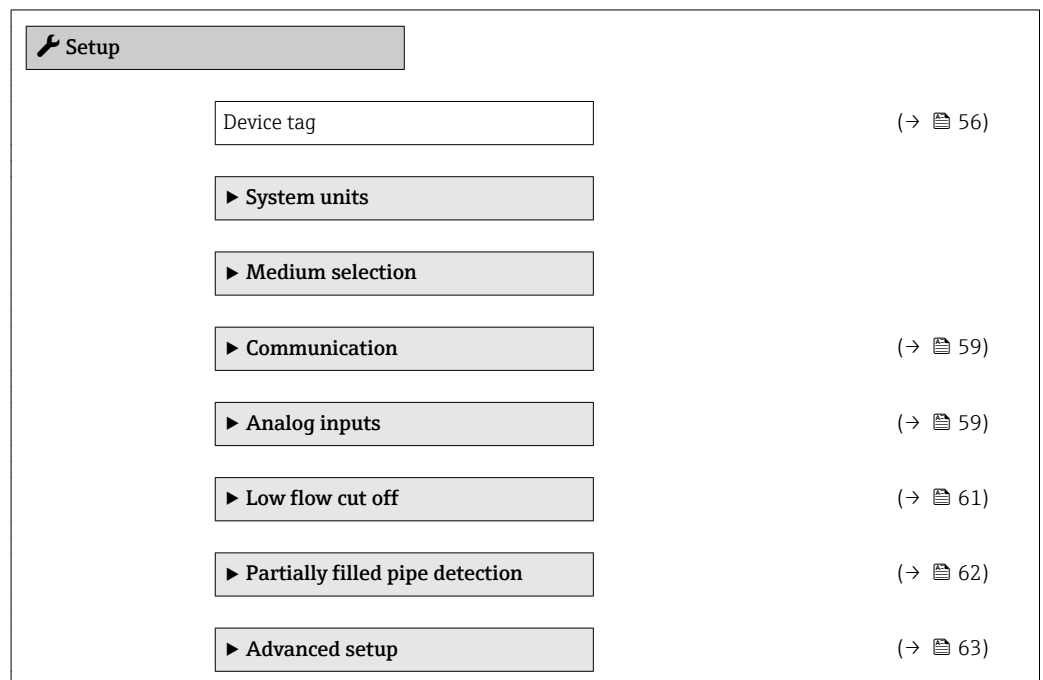

### 10.4 Configuring the measuring device

The **Setup** menu with its submenus contains all the parameters needed for standard operation.



#### 10.4.1 Defining the tag name

To enable fast identification of the measuring point within the system, you can enter a unique designation using the **Device tag** parameter and thus change the factory setting.

-  The number of characters displayed depends on the characters used.
-  For information on the tag name in the "FieldCare" operating tool (→  46)

### Navigation

"Setup" menu → Device tag

### Parameter overview with brief description

Parameter	Description	User entry	Factory setting
Device tag	Enter the name for the measuring point.	Max. 32 characters, such as letters, numbers or special characters (e.g. @, %, /).	Promass 100 DP

## 10.4.2 Setting the system units

In the **System units** submenu the units of all the measured values can be set.

-  Depending on the device version, not all submenus and parameters are available in every device. The selection can vary depending on the order code.

▶ System units

Mass flow unit

Mass unit

Volume flow unit

Volume unit

Corrected volume flow unit

Corrected volume unit

Density unit

Reference density unit

Temperature unit

Pressure unit



## Parameter overview with brief description

Parameter	Description	Selection	Factory setting
Mass flow unit	Select mass flow unit. <i>Result</i> The selected unit applies for: <ul style="list-style-type: none"> <li>▪ Output</li> <li>▪ Low flow cut off</li> <li>▪ Simulation process variable</li> </ul>	Unit choose list	Country-specific: <ul style="list-style-type: none"> <li>▪ kg/h</li> <li>▪ lb/min</li> </ul>
Mass unit	Select mass unit. <i>Result</i> The selected unit is taken from: <b>Mass flow unit</b> parameter	Unit choose list	Country-specific: <ul style="list-style-type: none"> <li>▪ kg</li> <li>▪ lb</li> </ul>
Volume flow unit	Select volume flow unit. <i>Result</i> The selected unit applies for: <ul style="list-style-type: none"> <li>▪ Output</li> <li>▪ Low flow cut off</li> <li>▪ Simulation process variable</li> </ul>	Unit choose list	Country-specific: <ul style="list-style-type: none"> <li>▪ l/h</li> <li>▪ gal/min (us)</li> </ul>
Volume unit	Select volume unit. <b>Result</b> The selected unit is taken from: <b>Volume flow unit</b> parameter	Unit choose list	Country-specific: <ul style="list-style-type: none"> <li>▪ l</li> <li>▪ gal (us)</li> </ul>
Corrected volume flow unit	Select corrected volume flow unit. <i>Result</i> The selected unit applies for: <ul style="list-style-type: none"> <li>▪ Output</li> <li>▪ Low flow cut off</li> <li>▪ Simulation process variable</li> </ul>	Unit choose list	Country-specific: <ul style="list-style-type: none"> <li>▪ NI/h</li> <li>▪ Sft<sup>3</sup>/h</li> </ul>
Corrected volume unit	Select corrected volume unit. <i>Result</i> The selected unit is taken from: <b>Corrected volume flow unit</b> parameter	Unit choose list	Country-specific: <ul style="list-style-type: none"> <li>▪ NI</li> <li>▪ Sft<sup>3</sup></li> </ul>
Density unit	Select density unit. <i>Result</i> The selected unit applies for: <ul style="list-style-type: none"> <li>▪ Output</li> <li>▪ Simulation process variable</li> </ul>	Unit choose list	Country-specific: <ul style="list-style-type: none"> <li>▪ kg/l</li> <li>▪ lb/ft<sup>3</sup></li> </ul>
Reference density unit	Select reference density unit.	Unit choose list	kg/NI
Temperature unit	Select temperature unit. <i>Result</i> The selected unit applies for: <ul style="list-style-type: none"> <li>▪ Output</li> <li>▪ Reference temperature</li> <li>▪ Simulation process variable</li> </ul>	Unit choose list	Country-specific: <ul style="list-style-type: none"> <li>▪ °C (Celsius)</li> <li>▪ °F (Fahrenheit)</li> </ul>
Pressure unit	Select process pressure unit.	Unit choose list	Country-specific: <ul style="list-style-type: none"> <li>▪ bar</li> <li>▪ psi</li> </ul>

### 10.4.3 Selecting and setting the medium

The **Medium selection** submenu contains parameters that have to be configured for selecting and setting the medium.

#### Navigation

"Setup" menu → Select medium

► Medium selection	
Select medium	(→ ⓘ 58)
Select gas type	(→ ⓘ 58)
Reference sound velocity	(→ ⓘ 58)
Temperature coefficient sound velocity	(→ ⓘ 58)
Pressure compensation	(→ ⓘ 58)
Pressure value	(→ ⓘ 58)
External pressure	(→ ⓘ 58)

#### Parameter overview with brief description

Parameter	Prerequisite	Description	Selection / User entry	Factory setting
Select medium	–	Select medium type.	Gas	Liquid
Select gas type	The following option is selected in the <b>Medium selection</b> parameter: Gas	Select measured gas type.	Gas type choose list	Methane CH <sub>4</sub>
Reference sound velocity	The following option is selected in the <b>Select gas type</b> parameter: Others	Enter sound velocity of gas at 0 °C (32 °F).	1 to 99 999.9999 m/s	0 m/s
Temperature coefficient sound velocity	The following option is selected in the <b>Select gas type</b> parameter: Others	Enter temperature coefficient for the gas sound velocity.	Positive floating-point number	0 (m/s)/K
Pressure compensation	The following option is selected in the <b>Medium selection</b> parameter: Gas	Select pressure compensation type.	<ul style="list-style-type: none"> <li>▪ Off</li> <li>▪ Fixed value</li> <li>▪ External value</li> </ul>	Off
Pressure value	The following option is selected in the <b>Pressure compensation</b> parameter: Fixed value	Enter process pressure to be used for pressure correction.	Positive floating-point number	0 bar
External pressure	The following option is selected in the <b>Pressure compensation</b> parameter: External value		Positive floating-point number	0 bar

### 10.4.4 Configuring the communication interface

The **"Communication"** submenu guides you systematically through all the parameters that have to be configured for selecting and setting the communication interface.

**Navigation**

"Setup" menu → Communication

A screenshot of a software interface showing a menu structure. At the top, there is a grey button labeled '► Communication'. Below it, centered, is a white rectangular input field with the text 'Device address' inside.

**Parameter overview with brief description**

Parameter	Description	User entry	Factory setting
Device address	Enter device address.	0 to 126	126

### 10.4.5 Configuring the analog inputs

The **Analog inputs** submenu guides you systematically to the individual **Analog input 1 to 4** submenu. From here you get to the parameters of the individual analog input.

**Navigation**

"Setup" menu → Analog inputs

A screenshot of a software interface showing a menu structure. At the top, there is a grey button labeled '► Analog inputs'. Below it, centered, is another grey button labeled '► Analog input 1 to 8'. Underneath this button are four white rectangular input fields, each containing a parameter name: 'Channel', 'PV filter time', 'Fail safe type', and 'Fail safe value'.

## Parameter overview with brief description

Parameter	Description	Selection / User entry	Factory setting
Channel	<p>Select the process variable.</p> <p> Depending on the device version, not all options are available in this parameter. The selection can vary depending on the sensor, e.g. viscosity is available only with the Promass I.</p>	<ul style="list-style-type: none"> <li>▪ Mass flow</li> <li>▪ Volume flow</li> <li>▪ Corrected volume flow</li> <li>▪ Target mass flow</li> <li>▪ Carrier mass flow</li> <li>▪ Density</li> <li>▪ Reference density</li> <li>▪ Concentration</li> <li>▪ Dynamic viscosity</li> <li>▪ Kinematic viscosity</li> <li>▪ Temp. compensated dynamic viscosity</li> <li>▪ Temp. compensated kinematic viscosity</li> <li>▪ Temperature</li> <li>▪ Carrier pipe temperature</li> <li>▪ Electronic temperature</li> <li>▪ Oscillation frequency 0</li> <li>▪ Oscillation frequency 1</li> <li>▪ Oscillation amplitude 0</li> <li>▪ Oscillation amplitude 1</li> <li>▪ Frequency fluctuation 0</li> <li>▪ Frequency fluctuation 1</li> <li>▪ Oscillation damping 0</li> <li>▪ Oscillation damping 1</li> <li>▪ Tube damping fluctuation 0</li> <li>▪ Tube damping fluctuation 1</li> <li>▪ Signal asymmetry</li> <li>▪ Exciter current 0</li> <li>▪ Exciter current 1</li> <li>▪ Sensor integrity</li> </ul>	Mass flow
PV filter time	Specify a time to suppress signal peaks. During the specified time the totalizer does not respond to an erratic increase in the process variable.	Positive floating-point number	0
Fail safe type	Select the failure mode.	<ul style="list-style-type: none"> <li>▪ Fail safe value</li> <li>▪ Fallback value</li> <li>▪ Off</li> </ul>	Off
Fail safe value	Specify the value to be output when an error occurs.	Signed floating-point number	0

### 10.4.6 Configuring the low flow cut off

The **Low flow cut off** submenu contains parameters that must be configured for the configuration of low flow cut off.

#### Navigation

"Setup" menu → Low flow cut off

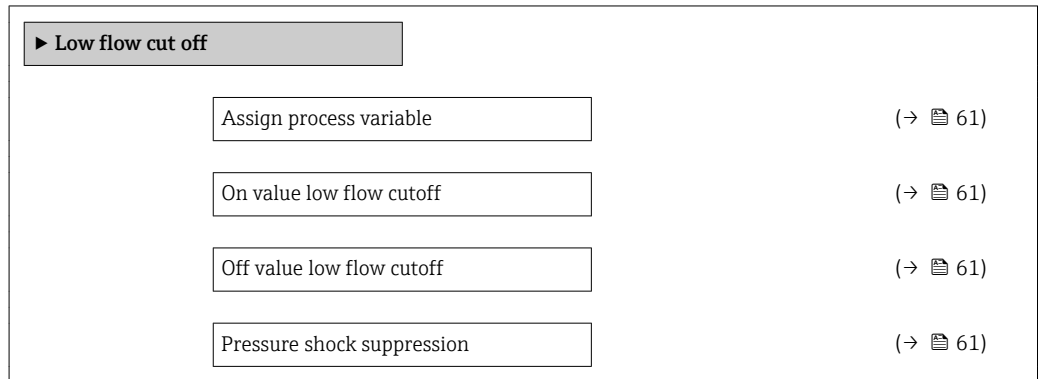

#### Parameter overview with brief description

Parameter	Prerequisite	Description	Selection / User entry	Factory setting
Assign process variable	–	Select process variable for low flow cut off.	<ul style="list-style-type: none"> <li>▪ Off</li> <li>▪ Mass flow</li> <li>▪ Volume flow</li> <li>▪ Corrected volume flow</li> </ul>	Mass flow
On value low flow cutoff	In the <b>Assign process variable</b> parameter, one of the following options is selected: <ul style="list-style-type: none"> <li>▪ Mass flow</li> <li>▪ Volume flow</li> <li>▪ Corrected volume flow</li> </ul>	Enter on value for low flow cut off.	Positive floating-point number	For liquids: depends on country and nominal diameter
Off value low flow cutoff	In the <b>Assign process variable</b> parameter, one of the following options is selected: <ul style="list-style-type: none"> <li>▪ Mass flow</li> <li>▪ Volume flow</li> <li>▪ Corrected volume flow</li> </ul>	Enter off value for low flow cut off.	0 to 100.0 %	50 %
Pressure shock suppression	In the <b>Assign process variable</b> parameter, one of the following options is selected: <ul style="list-style-type: none"> <li>▪ Mass flow</li> <li>▪ Volume flow</li> <li>▪ Corrected volume flow</li> </ul>	Enter time frame for signal suppression (= active pressure shock suppression).	0 to 100 s	0 s

### 10.4.7 Configuring the partial filled pipe detection

The **Partially filled pipe detection** submenu contains parameters that have to be set for configuring empty pipe detection.

#### Navigation

"Setup" menu → Partially filled pipe detection

▶ <b>Partially filled pipe detection</b>	
Assign process variable	(→ ⓘ 62)
Low value partial filled pipe detection	(→ ⓘ 62)
High value partial filled pipe detection	(→ ⓘ 62)
Response time part. filled pipe detect.	(→ ⓘ 62)

#### Parameter overview with brief description

Parameter	Prerequisite	Description	Selection / User entry	Factory setting
Assign process variable	–	Select process variable for partially filled pipe detection.	<ul style="list-style-type: none"> <li>■ Off</li> <li>■ Density</li> <li>■ Reference density</li> </ul>	Off
Low value partial filled pipe detection	One of the following options is selected in the <b>Assign process variable</b> parameter: <ul style="list-style-type: none"> <li>■ Density</li> <li>■ Reference density</li> </ul>	Enter lower limit value for deactivating partially filled pipe detection.	Signed floating-point number	Country-dependent: <ul style="list-style-type: none"> <li>■ 0.2 kg/l</li> <li>■ 12.5 lb/ft<sup>3</sup></li> </ul>
High value partial filled pipe detection	One of the following options is selected in the <b>Assign process variable</b> parameter: <ul style="list-style-type: none"> <li>■ Density</li> <li>■ Reference density</li> </ul>	Enter upper limit value for deactivating partially filled pipe detection.	Signed floating-point number	Country-dependent: <ul style="list-style-type: none"> <li>■ 6 kg/l</li> <li>■ 374.6 lb/ft<sup>3</sup></li> </ul>
Response time part. filled pipe detect.	One of the following options is selected in the <b>Assign process variable</b> parameter: <ul style="list-style-type: none"> <li>■ Density</li> <li>■ Reference density</li> </ul>	Enter time before diagnostic message is displayed for partially filled pipe detection.	0 to 100 s	1 s

## 10.5 Advanced settings





The **Advanced setup** submenu with its submenus contains parameters for specific settings.

 The number of submenus can vary depending on the device version, e.g. viscosity is available only with the Promass I.

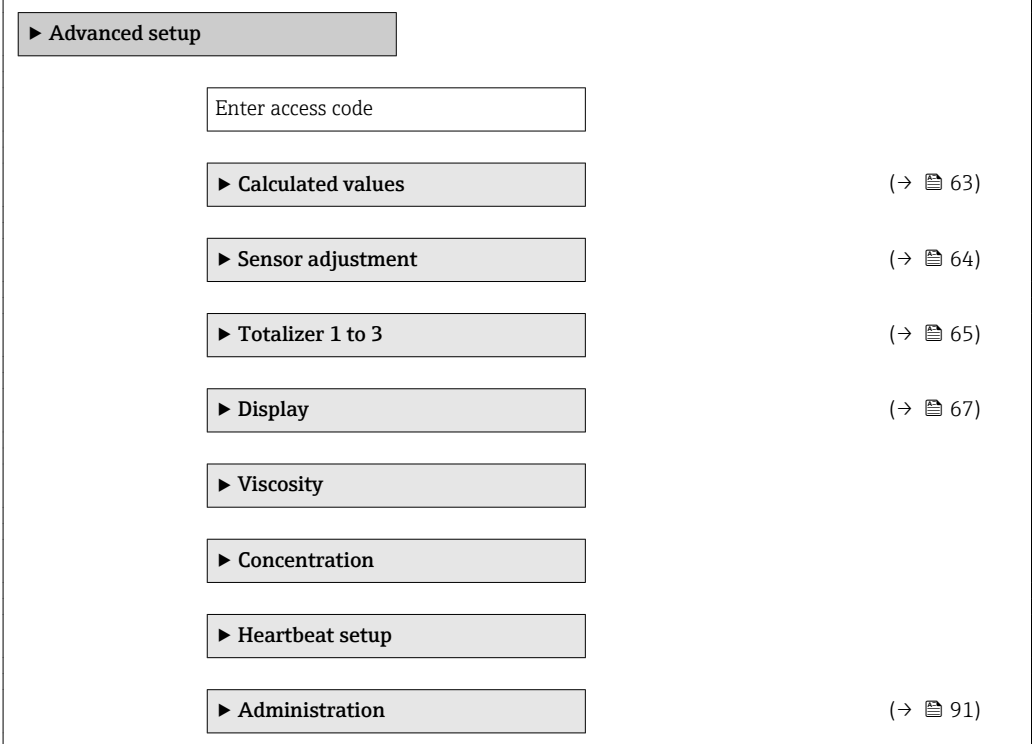
### Navigation

"Setup" menu → Advanced setup



▶ Advanced setup	
Enter access code	
▶ Calculated values	(→  63)
▶ Sensor adjustment	(→  64)
▶ Totalizer 1 to 3	(→  65)
▶ Display	(→  67)
▶ Viscosity	
▶ Concentration	
▶ Heartbeat setup	
▶ Administration	(→  91)





### 10.5.1 Calculated values

The **Calculated values** submenu contains parameters for calculating the corrected volume flow.

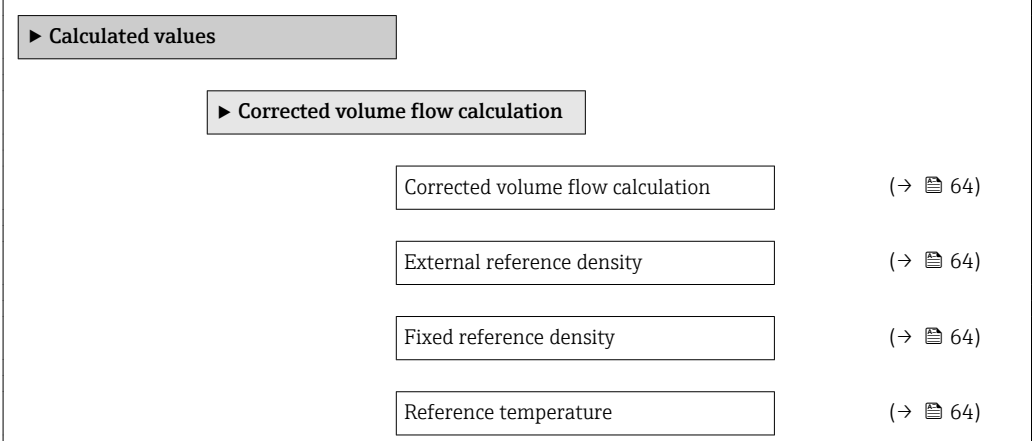
### Navigation

"Setup" menu → Advanced setup → Calculated values



▶ Calculated values	
▶ Corrected volume flow calculation	
Corrected volume flow calculation	(→  64)
External reference density	(→  64)
Fixed reference density	(→  64)
Reference temperature	(→  64)

Linear expansion coefficient	(→ ⓘ 64)
Square expansion coefficient	(→ ⓘ 64)

### Parameter overview with brief description

Parameter	Prerequisite	Description	Selection / User entry	Factory setting
Corrected volume flow calculation	–	Select reference density for calculating the corrected volume flow.	<ul style="list-style-type: none"> <li>▪ Fixed reference density</li> <li>▪ Calculated reference density</li> <li>▪ Reference density by API table 53</li> <li>▪ External reference density</li> </ul>	Calculated reference density
External reference density	–	Shows external reference density.	Floating point number with sign	0 kg/Nl
Fixed reference density	The following option is selected in the <b>Corrected volume flow calculation</b> parameter: Fixed reference density	Enter fixed value for reference density.	Positive floating-point number	1 kg/Nl
Reference temperature	The following option is selected in the <b>Corrected volume flow calculation</b> parameter: Calculated reference density	Enter reference temperature for calculating the reference density.	–273.15 to 99 999 °C	20 °C
Linear expansion coefficient	The following option is selected in the <b>Corrected volume flow calculation</b> parameter: Calculated reference density	Enter linear, medium-specific expansion coefficient for calculating the reference density.	Signed floating-point number	0.0
Square expansion coefficient	–	For media with a non-linear expansion pattern: enter the quadratic, medium-specific expansion coefficient for calculating the reference density.	Signed floating-point number	0.0

## 10.5.2 Carrying out a sensor adjustment

The **Sensor adjustment** submenu contains parameters that pertain to the functionality of the sensor.

### Navigation

"Setup" menu → Advanced setup → Sensor adjustment



▶ Sensor adjustment

Installation direction

(→ ⓘ 65)

▶ Zero point adjustment

Zero point adjustment control

(→ ⓘ 65)

Progress

(→ ⓘ 65)

**Parameter overview with brief description**

Parameter	Description	Selection / User interface	Factory setting
Installation direction	Set sign of flow direction to match the direction of the arrow on the sensor.	<ul style="list-style-type: none"> <li>▪ Flow in arrow direction</li> <li>▪ Flow against arrow direction</li> </ul>	Flow in arrow direction
Zero point adjustment control	Start zero point adjustment.	<ul style="list-style-type: none"> <li>▪ Cancel</li> <li>▪ Busy</li> <li>▪ Zero point adjust failure</li> <li>▪ Start</li> </ul>	Cancel
Progress	Shows the progress of the process.	0 to 100 %	0 %

**10.5.3 Configuring the totalizer**

In the "Totalizer 1 to 3" submenu the individual totalizer can be configured.

**Navigation**

"Setup" menu → Advanced setup → Totalizer 1 to 3

▶ Totalizer 1 to 3

Assign process variable

Unit totalizer

Totalizer operation mode

Failure mode

**Parameter overview with brief description**

Parameter	Description	Selection	Factory setting
Assign process variable	Assignment of a process variable to the totalizer.	<ul style="list-style-type: none"> <li>▪ Mass flow</li> <li>▪ Volume flow</li> <li>▪ Corrected volume flow</li> <li>▪ Target mass flow</li> <li>▪ Carrier mass flow</li> </ul>	Mass flow
Unit totalizer	Select the unit for the totalizer.	Unit choose list	kg

Parameter	Description	Selection	Factory setting
Totalizer operation mode	Select totalizer calculation mode.	<ul style="list-style-type: none"><li>■ Net flow total</li><li>■ Forward flow total</li><li>■ Reverse flow total</li><li>■ Last valid value</li></ul>	Net flow total
Failure mode	Select the failure mode.	<ul style="list-style-type: none"><li>■ Stop</li><li>■ Actual value</li><li>■ Last valid value</li></ul>	Actual value

### 10.5.4 Carrying out additional display configurations

In the **"Display"** submenu you can set all the parameters involved in the configuration of the local display.

#### Navigation

"Setup" menu → Advanced setup → Display

► Display

Format display

Value 1 display

0% bargraph value 1

100% bargraph value 1

Decimal places 1

Value 2 display

Decimal places 2

Value 3 display

0% bargraph value 3

100% bargraph value 3

Decimal places 3

Value 4 display

Decimal places 4

Display language

Display interval

Display damping

Header

Header text

Separator

Backlight

## Parameter overview with brief description

Parameter	Prerequisite	Description	Selection / User entry	Factory setting
Format display	–	Select how measured values are shown on the display.	<ul style="list-style-type: none"> <li>▪ 1 value, max. size</li> <li>▪ 1 bargraph + 1 value</li> <li>▪ 2 values</li> <li>▪ 1 value large + 2 values</li> <li>▪ 4 values</li> </ul>	1 value, max. size
Value 1 display	–	<p>Select the measured value that is shown on the local display.</p> <p> Depending on the device version, not all options are available in this parameter. The selection can vary depending on the sensor, e.g. viscosity is available only with the Promass I.</p>	<ul style="list-style-type: none"> <li>▪ Mass flow</li> <li>▪ Volume flow</li> <li>▪ Corrected volume flow</li> <li>▪ Target mass flow</li> <li>▪ Carrier mass flow</li> <li>▪ Density</li> <li>▪ Reference density</li> <li>▪ Concentration</li> <li>▪ Dynamic viscosity</li> <li>▪ Kinematic viscosity</li> <li>▪ Temp. compensated dynamic viscosity</li> <li>▪ Temp. compensated kinematic viscosity</li> <li>▪ Temperature</li> <li>▪ Carrier pipe temperature</li> <li>▪ Electronic temperature</li> <li>▪ Oscillation frequency 0</li> <li>▪ Oscillation frequency 1</li> <li>▪ Oscillation amplitude 0</li> <li>▪ Oscillation amplitude 1</li> <li>▪ Frequency fluctuation 0</li> <li>▪ Frequency fluctuation 1</li> <li>▪ Oscillation damping 0</li> <li>▪ Oscillation damping 1</li> <li>▪ Tube damping fluctuation 0</li> <li>▪ Tube damping fluctuation 1</li> <li>▪ Signal asymmetry</li> <li>▪ Exciter current 0</li> <li>▪ Exciter current 1</li> <li>▪ Sensor integrity</li> <li>▪ None</li> <li>▪ Totalizer 1</li> <li>▪ Totalizer 2</li> <li>▪ Totalizer 3</li> </ul>	Mass flow
0% bargraph value 1	–	Enter 0% value for bar graph display.	Signed floating-point number	0 kg/h
100% bargraph value 1	–	Enter 100% value for bar graph display.	Signed floating-point number	2.5 kg/h

Parameter	Prerequisite	Description	Selection / User entry	Factory setting
Decimal places 1	–	Select the number of decimal places for the display value.	<ul style="list-style-type: none"> <li>■ x</li> <li>■ x.x</li> <li>■ x.xx</li> <li>■ x.xxx</li> <li>■ x.xxxx</li> </ul>	x.xx
Value 2 display	–	Select the measured value that is shown on the local display.	Picklist (see 1st display value)	None
Decimal places 2	–	Select the number of decimal places for the display value.	<ul style="list-style-type: none"> <li>■ x</li> <li>■ x.x</li> <li>■ x.xx</li> <li>■ x.xxx</li> <li>■ x.xxxx</li> </ul>	x.xx
Value 3 display	–	Select the measured value that is shown on the local display.	Picklist (see 1st display value)	None
0% bargraph value 3	An option was selected in the <b>Value 3 display</b> parameter.	Enter 0% value for bar graph display.	Signed floating-point number	0
100% bargraph value 3	An option was selected in the <b>Value 3 display</b> parameter.	Enter 100% value for bar graph display.	Signed floating-point number	0
Decimal places 3	–	Select the number of decimal places for the display value.	<ul style="list-style-type: none"> <li>■ x</li> <li>■ x.x</li> <li>■ x.xx</li> <li>■ x.xxx</li> <li>■ x.xxxx</li> </ul>	x.xx
Value 4 display	–	Select the measured value that is shown on the local display.	Picklist (see 1st display value)	None
Decimal places 4	–	Select the number of decimal places for the display value.	<ul style="list-style-type: none"> <li>■ x</li> <li>■ x.x</li> <li>■ x.xx</li> <li>■ x.xxx</li> <li>■ x.xxxx</li> </ul>	x.xx
Display language	–	Set display language.	<ul style="list-style-type: none"> <li>■ English</li> <li>■ Deutsch</li> <li>■ Français</li> <li>■ Español</li> <li>■ Italiano</li> <li>■ Nederlands</li> <li>■ Portuguesa</li> <li>■ Polski</li> <li>■ русский язык (Russian)</li> <li>■ Svenska</li> <li>■ Türkçe</li> <li>■ 中文 (Chinese)</li> <li>■ 日本語 (Japanese)</li> <li>■ 한국어 (Korean)</li> <li>■ العربية (Arabic)</li> <li>■ Bahasa Indonesia</li> <li>■ ภาษาไทย (Thai)</li> <li>■ tiếng Việt (Vietnamese)</li> <li>■ čeština (Czech)</li> </ul>	English (alternatively, the ordered language is preset in the device)
Display interval	–	Set time measured values are shown on display if display alternates between values.	1 to 10 s	5 s
Display damping	–	Set display reaction time to fluctuations in the measured value.	0.0 to 999.9 s	0.0 s
Header	–	Select header contents on local display.	<ul style="list-style-type: none"> <li>■ Device tag</li> <li>■ Free text</li> </ul>	Device tag
Header text	–	Enter display header text.		-----

Parameter	Prerequisite	Description	Selection / User entry	Factory setting
Separator	–	Select decimal separator for displaying numerical values.	<ul style="list-style-type: none"> <li>▪ .</li> <li>▪ ,</li> </ul>	.
Backlight	–	Switch the local display backlight on and off.  Only for device version with onsite display SD03 (touch control)	<ul style="list-style-type: none"> <li>▪ Disable</li> <li>▪ Enable</li> </ul>	Enable

## 10.6 Simulation

The "**Simulation**" submenu enables you to simulate, without a real flow situation, various process variables in the process and the device alarm mode and to verify downstream signal chains (switching valves or closed-control loops).

### Navigation

"Diagnostics" menu → Simulation

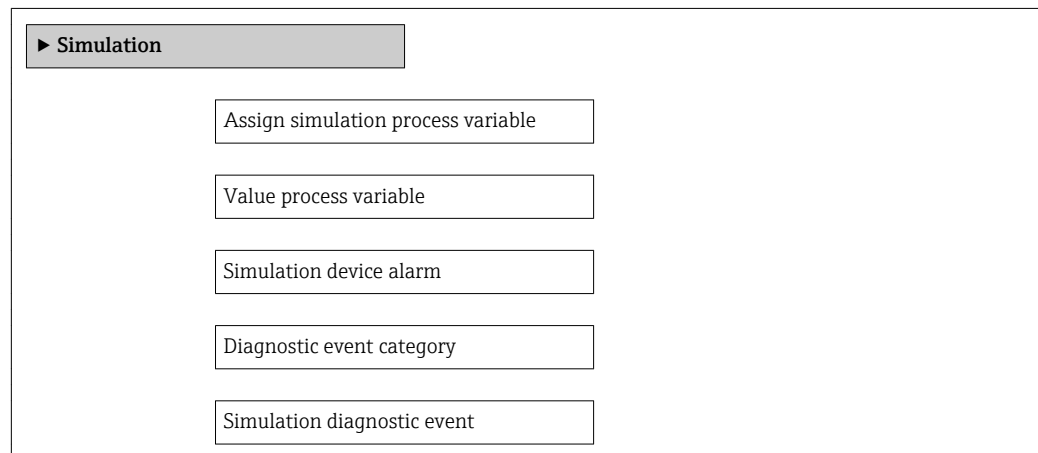



**Parameter overview with brief description**

Parameter	Prerequisite	Description	Selection / User entry	Factory setting
Assign simulation process variable	–	Select a process variable for the simulation process that is activated.   Depending on the device version, not all options are available in this parameter. The selection can vary depending on the sensor, e.g. viscosity is available only with the Promass I.	<ul style="list-style-type: none"> <li>▪ Off</li> <li>▪ Mass flow</li> <li>▪ Volume flow</li> <li>▪ Corrected volume flow</li> <li>▪ Density</li> <li>▪ Reference density</li> <li>▪ Temperature</li> <li>▪ Dynamic viscosity</li> <li>▪ Kinematic viscosity</li> <li>▪ Temp. compensated dynamic viscosity</li> <li>▪ Temp. compensated kinematic viscosity</li> <li>▪ Concentration</li> <li>▪ Target mass flow</li> <li>▪ Carrier mass flow</li> </ul>	Off
Value process variable	A process variable is selected in the <b>Assign simulation process variable</b> parameter.	Enter the simulation value for the selected process variable.	Signed floating-point number	0
Simulation device alarm	–	Switch the device alarm on and off.	<ul style="list-style-type: none"> <li>▪ Off</li> <li>▪ On</li> </ul>	Off
Diagnostic event category	–	Select the category of the diagnostic event.	<ul style="list-style-type: none"> <li>▪ Sensor</li> <li>▪ Electronics</li> <li>▪ Configuration</li> <li>▪ Process</li> </ul>	Process
Simulation diagnostic event	–	Switch simulation of the diagnostic event on and off.  For the simulation, you can choose from the diagnostic events of the category selected in the <b>Diagnostic event category</b> parameter.	<ul style="list-style-type: none"> <li>▪ Off</li> <li>▪ Picklist Diagnostic events (depends on the selected category)</li> </ul>	Off

## 10.7 Protecting settings from unauthorized access

The following options exist for protecting the configuration of the measuring device from unintentional modification after commissioning:

- Write protection via access code for Web browser (→  71)
- Write protection via write protection switch (→  72)

### 10.7.1 Write protection via access code

With the customer-specific access code, access to the measuring device via the Web browser is protected, as are the parameters for the measuring device configuration.

#### Navigation

"Setup" menu → Advanced setup → Administration → Define access code

*Structure of the submenu*

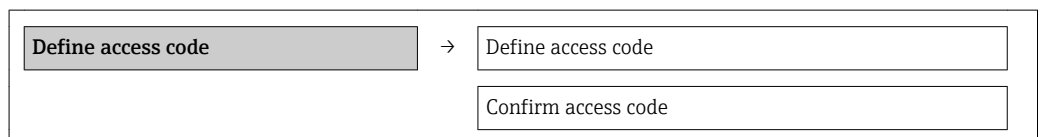

### Defining the access code via the Web browser

1. Navigate to the **Enter access code** parameter.
2. Define a max. 4-digit numeric code as an access code.
3. Enter the access code again to confirm the code.
  - ↳ The Web browser switches to the login page.

**i** If no action is performed for 10 minutes, the Web browser automatically returns to the login page.

**i** The user role with which the user is currently logged on via the Web browser is indicated by the **Access status tooling** parameter. Navigation path: Operation → Access status tooling

### 10.7.2 Write protection via write protection switch

The write protection switch makes it possible to block write access to the entire operating menu with the exception of the following parameters:

- External pressure
- External temperature
- Reference density
- All parameters for configuring the totalizer

The parameter values are now read only and cannot be edited any more:

- Via service interface (CDI-RJ45)
- Via PROFIBUS DP

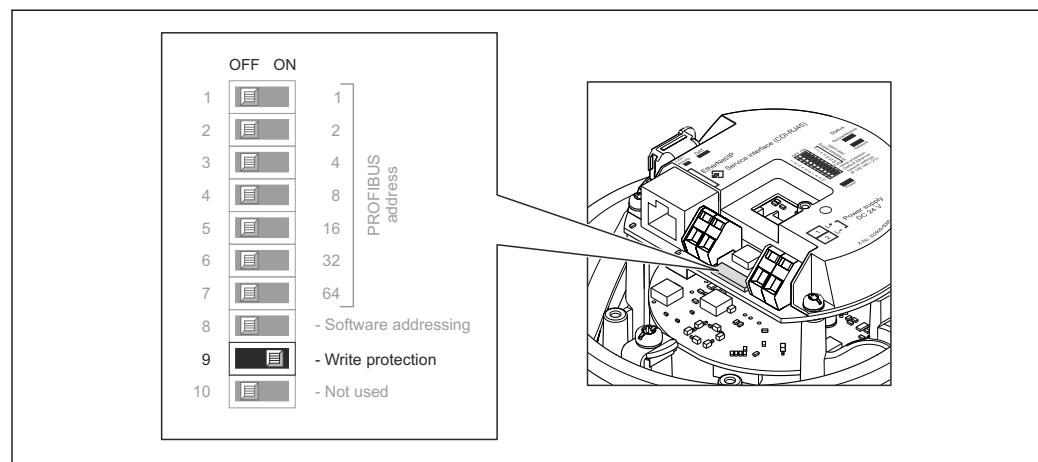

A0021262

1. Depending on the housing version, loosen the securing clamp or fixing screw of the housing cover.
2. Depending on the housing version, unscrew or open the housing cover and disconnect the local display from the main electronics module where necessary (→ 115).
3. Setting the write protection switch on the main electronics module to the ON position enables the hardware write protection. Setting the write protection switch on the main electronics module to the OFF position (factory setting) disables the hardware write protection.
  - ↳ If hardware write protection is enabled: the **Locking status** parameter displays the **Hardware locked** option (→ 73); if disabled, the **Locking status** parameter does not display any option (→ 73)
4. Reverse the removal procedure to reassemble the transmitter.



## 11 Operation

### 11.1 Reading device locking status

The write protection types that are currently active can be determined using the **Locking status** parameter.

#### Navigation

"Operation" menu → Locking status

*Function scope of "Locking status" parameter*

Options	Description
Hardware locked	The write protection switch (DIP switch) for hardware locking is activated on the I/O electronic module. This prevents write access to the parameters (→ 72).
Temporarily locked	Due to internal processing in the device (e.g. up-/downloading of data, reset), write access to the parameters is blocked for a short time. Once the internal processing has been completed, the parameters can be changed once again.

### 11.2 Adjusting the operating language

Information (→ 55)

 For information on the operating languages supported by the measuring device (→ 116)

### 11.3 Configuring the display

- Basic settings for local display
- Advanced settings for local display (→ 67)

### 11.4 Reading measured values

Using the **Measured values** submenu, it is possible to read all the measured values.

"Diagnostics" menu → Measured values

#### 11.4.1 Process variables

The **Process variables** submenu contains all the parameters needed to display the current measured values for every process variable.

#### Navigation

"Diagnostics" menu → Measured values → Process variables

<b>Process variables</b>	Mass flow
	Volume flow
	Corrected volume flow
	Density
	Reference density

	Temperature
	Pressure value

**Parameter overview with brief description**

Parameter	Description	User interface
Mass flow	Displays the mass flow currently measured.	Signed floating-point number
Volume flow	Displays the volume flow currently calculated. <i>Dependency</i> The unit is taken from the <b>Volume flow unit</b> parameter	Signed floating-point number
Corrected volume flow	Displays the corrected volume flow currently calculated. <i>Dependency</i> The unit is taken from the <b>Corrected volume flow unit</b> parameter	Signed floating-point number
Density	Displays the density currently measured. <i>Dependency</i> The unit is taken from the <b>Density unit</b> parameter	Signed floating-point number
Reference density	Displays the reference density currently calculated. <i>Dependency</i> The unit is taken from the <b>Reference density unit</b> parameter	Signed floating-point number
Temperature	Shows the medium temperature currently measured. <i>Dependency</i> The unit is taken from the <b>Temperature unit</b> parameter	Signed floating-point number
Pressure value	Displays either a fixed or external pressure value.	Signed floating-point number

**11.4.2 Totalizer**

The "**Totalizer**" submenu contains all the parameters needed to display the current measured values for every totalizer.

**Navigation**

"Diagnostics" menu → Measured values → Totalizer 1 to 3

<p>► <b>Totalizer 1 to 3</b></p> <p>Assign process variable</p> <p>Totalizer value 1 to 3</p> <p>Totalizer status 1 to 3</p> <p>Totalizer status (Hex) 1 to 3</p>
---

**Parameter overview with brief description**

Parameter	Prerequisite	Description	Selection / User entry / User interface	Factory setting
Assign process variable	–	Assignment of a process variable to the totalizer.	<ul style="list-style-type: none"> <li>■ Mass flow</li> <li>■ Volume flow</li> <li>■ Corrected volume flow</li> <li>■ Target mass flow</li> <li>■ Carrier mass flow</li> </ul>	Mass flow
Totalizer value 1 to 3	In the <b>Assign process variable</b> parameter one of the following options is selected: <ul style="list-style-type: none"> <li>■ Volume flow</li> <li>■ Mass flow</li> <li>■ Corrected volume flow</li> <li>■ Total mass flow</li> <li>■ Condensate mass flow</li> <li>■ Energy flow</li> <li>■ Heat flow difference</li> </ul>	Displays the current totalizer counter value.	Signed floating-point number	0 kg
Totalizer status 1 to 3	–	Displays the current totalizer status.	<ul style="list-style-type: none"> <li>■ Good</li> <li>■ Uncertain</li> <li>■ Bad</li> </ul>	Good
Totalizer status (Hex) 1 to 3	–	Displays the current status value (hex) of the totalizer.	0 to 255	128

**11.4.3 Output values**

The "Output values" submenu contains all the parameters needed to display the current measured values for every output.

**Navigation**

"Diagnostics" menu → Measured values → Output values

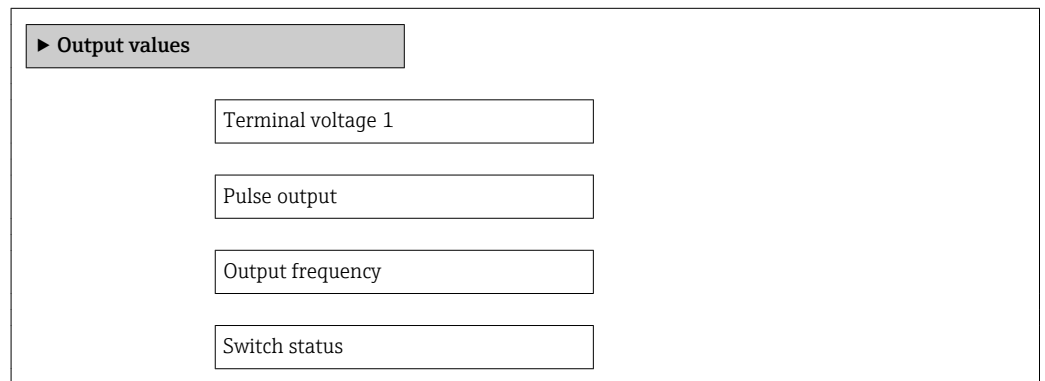

**Parameter overview with brief description**

Parameter	Description	User interface	Factory setting
Pulse output	Displays the value currently measured for the pulse output.	Positive floating-point number	0 Hz
Output frequency	Displays the value currently measured for the frequency output.	0.0 to 1250.0 Hz	0.0 Hz
Switch status	Displays the current switch output status.	<ul style="list-style-type: none"> <li>■ Open</li> <li>■ Closed</li> </ul>	Open

## 11.5 Adapting the measuring device to the process conditions

The following are available for this purpose:

- Basic settings using the **Setup** menu(→  55)
- Advanced settings using the **Advanced setup** submenu(→  63)

## 11.6 Performing a totalizer reset

In the **Operation** submenu the totalizers are reset:  
Control Totalizer 1 to 3

*Function scope of "Control Totalizer " parameter*

Options	Description
Totalize	The totalizer is started.
Reset + hold	The totaling process is stopped and the totalizer is reset to 0.
Preset + hold	The totaling process is stopped and the totalizer is set to its defined start value from the <b>Preset value 1 to 3</b> parameter.

### Navigation

"Operation" menu → Operation

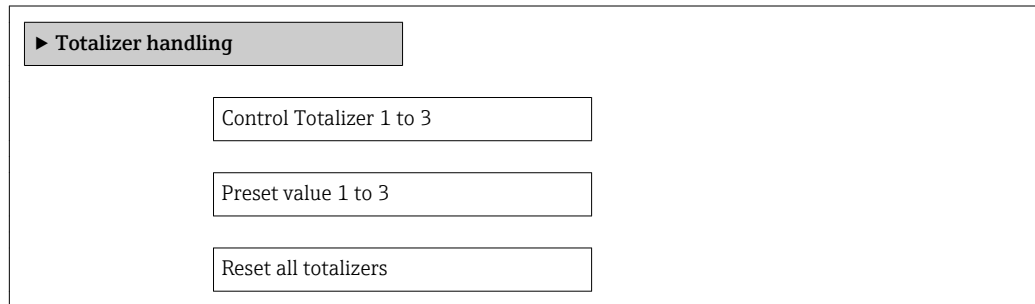

### Parameter overview with brief description

Parameter	Description	Selection / User entry	Factory setting
Control Totalizer #	Control totalizer value.	<ul style="list-style-type: none"> <li>▪ Totalize</li> <li>▪ Reset + hold</li> <li>▪ Preset + hold</li> </ul>	Totalize
Preset value #	Specify start value for totalizer.	Signed floating-point number	0 kg
Reset all totalizers	Reset all totalizers to 0 and start.	<ul style="list-style-type: none"> <li>▪ Cancel</li> <li>▪ Reset + totalize</li> </ul>	Cancel

## 12 Diagnostics and troubleshooting

### 12.1 General troubleshooting

*For local display*

Problem	Possible causes	Remedial action
Local display dark and no output signals	Supply voltage does not match that specified on the nameplate.	Apply the correct supply voltage (→ 32).
Local display dark and no output signals	Supply voltage has incorrect polarity.	Reverse polarity of supply voltage.
Local display dark and no output signals	No contact between connecting cables and terminals.	Check the connection of the cables and correct if necessary.
Local display dark and no output signals	Terminals are not plugged into the I/O electronics module correctly.	Check terminals.
Local display dark and no output signals	I/O electronics module is defective.	Order spare part (→ 96).
Local display is dark, but signal output is within the valid range	Display is set too bright or too dark.	<ul style="list-style-type: none"> <li>▪ Set the display brighter by simultaneously pressing  + .</li> <li>▪ Set the display darker by simultaneously pressing  + .</li> </ul>
Local display is dark, but signal output is within the valid range	The cable of the display module is not plugged in correctly.	Insert the plug correctly into the main electronics module and display module.
Local display is dark, but signal output is within the valid range	Display module is defective.	Order spare part (→ 96).
Backlighting of local display is red	Diagnostic event with "Alarm" diagnostic behavior has occurred.	Take remedial measures (→ 85)
Message on local display: "Communication Error" "Check Electronics"	Communication between the display module and the electronics is interrupted.	<ul style="list-style-type: none"> <li>▪ Check the cable and the connector between the main electronics module and display module.</li> <li>▪ Order spare part (→ 96).</li> </ul>

*For output signals*

Problem	Possible causes	Remedial action
Green power LED on the main electronics module of the transmitter is dark	Supply voltage does not match that specified on the nameplate.	Apply the correct supply voltage (→ 32).
Device measures incorrectly.	Configuration error or device is operated outside the application.	<ol style="list-style-type: none"> <li>1. Check and correct parameter configuration.</li> <li>2. Observe limit values specified in the "Technical Data".</li> </ol>

*For access*

Problem	Possible causes	Remedial action
No write access to parameters	Hardware write protection enabled	Set the write protection switch on the main electronics module to the OFF position (→ 72).
No connection via PROFIBUS DP	PROFIBUS DP bus cable connected incorrectly	Check the terminal assignment .
No connection via PROFIBUS DP	Device plug connected incorrectly	Check the pin assignment of the device plug .

Problem	Possible causes	Remedial action
No connection via PROFIBUS DP	PROFIBUS DP cable incorrectly terminated	Check terminating resistor (→ 34).
Not connecting to Web server	Incorrect setting for the Ethernet interface of the computer	1. Check the properties of the Internet protocol (TCP/IP) (→ 40). 2. Check the network settings with the IT manager.
Not connecting to Web server	Web server disabled	Via the "FieldCare" operating tool check whether the Web server of the measuring device is enabled and enable it if necessary (→ 43).
No or incomplete display of contents in the Web browser	<ul style="list-style-type: none"> <li>▪ JavaScript not enabled</li> <li>▪ JavaScript cannot be enabled</li> </ul>	1. Enable JavaScript. 2. Enter http://XXX.XXX.X.XXX/basic.html as the IP address.
Web browser frozen and operation no longer possible	Data transfer active	Wait until data transfer or current action is finished.
Web browser frozen and operation no longer possible	Connection lost	1. Check cable connection and power supply. 2. Refresh the Web browser and restart if necessary.
Content of Web browser incomplete or difficult to read	Not using optimum version of Web server.	1. Use the correct Web browser version (→ 40). 2. Clear the Web browser cache and restart the Web browser.
Content of Web browser incomplete or difficult to read	Unsuitable view settings.	Change the font size/display ratio of the Web browser.

## 12.2 Diagnostic information via light emitting diodes

### 12.2.1 Transmitter

Various light emitting diodes (LEDs) on the main electronics module of the transmitter provide information on device status.

LED	Color	Meaning
Power	Off	Supply voltage is off or too low
	Green	Supply voltage is ok
Alarm	Off	Device status is ok
	Flashing red	A device error of diagnostic behavior "Warning" has occurred
	Red	<ul style="list-style-type: none"> <li>▪ A device error of diagnostic behavior "Alarm" has occurred</li> <li>▪ Boot loader is active</li> </ul>
Communication	Flashing white	PROFIBUS DP communication is active

## 12.3 Diagnostic information on local display

### 12.3.1 Diagnostic message

Faults detected by the self-monitoring system of the measuring device are displayed as a diagnostic message in alternation with the operational display.

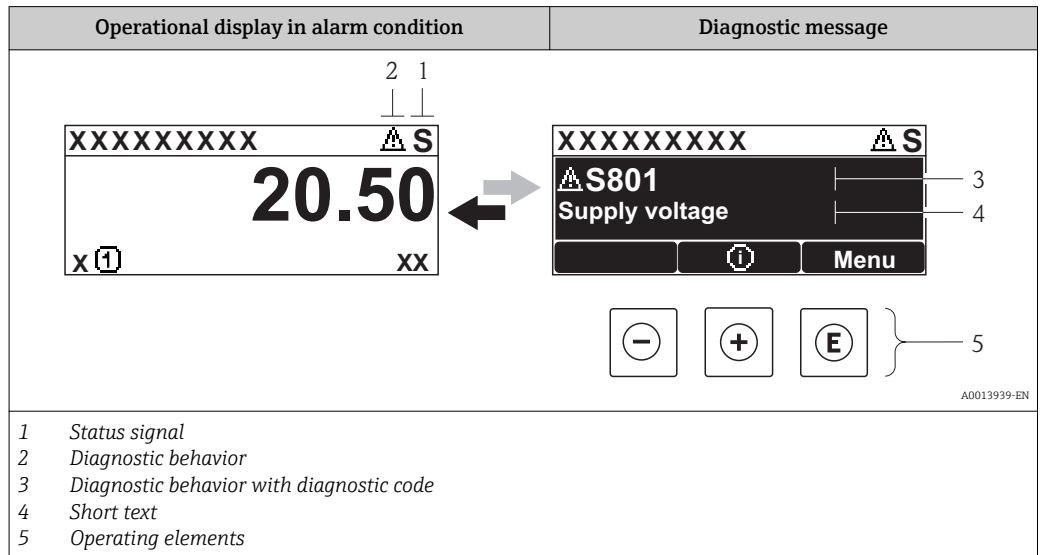

If two or more diagnostic events are pending simultaneously, only the message of the diagnostic event with the highest priority is shown.

- i** Other diagnostic events that have occurred can be called up in the **Diagnostics** menu:
  - Via parameters (→ 88)
  - Via submenus (→ 89)



#### Status signals

The status signals provide information on the state and reliability of the device by categorizing the cause of the diagnostic information (diagnostic event).

- i** The status signals are categorized according to VDI/VDE 2650 and NAMUR Recommendation NE 107: F = Failure, C = Function Check, S = Out of Specification, M = Maintenance Required

Symbol	Meaning
<b>F</b> <small>A0013956</small>	<b>Failure</b> A device error has occurred. The measured value is no longer valid.
<b>C</b> <small>A0013959</small>	<b>Function check</b> The device is in service mode (e.g. during a simulation).
<b>S</b> <small>A0013958</small>	<b>Out of specification</b> The device is operated: Outside its technical specification limits (e.g. outside the process temperature range)
<b>M</b> <small>A0013957</small>	<b>Maintenance required</b> Maintenance is required. The measured value remains valid.

### Diagnostic behavior



Symbol	Meaning
 <small>A0013961</small>	<b>Alarm</b> <ul style="list-style-type: none"> <li>▪ Measurement is interrupted.</li> <li>▪ Signal outputs and totalizers assume the defined alarm condition.</li> <li>▪ A diagnostic message is generated.</li> </ul>
 <small>A0013962</small>	<b>Warning</b> Measurement is resumed. The signal outputs and totalizers are not affected. A diagnostic message is generated.

### Diagnostic information

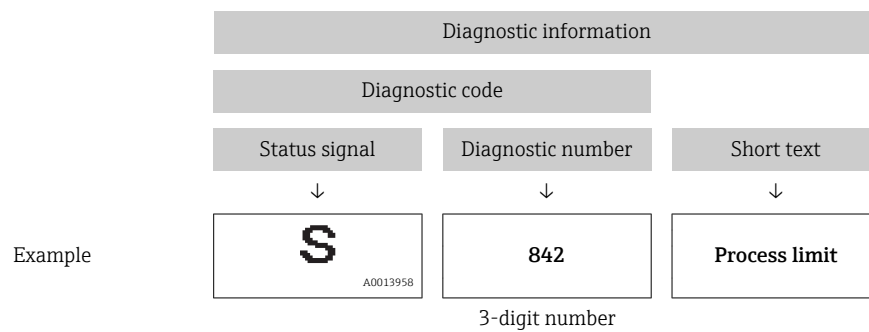
The fault can be identified using the diagnostic information. The short text helps you by providing information about the fault.



### Operating elements

Key	Meaning
 <small>A0013970</small>	<b>Plus key</b> <i>In a menu, submenu</i> Opens the message about the remedial measures.
 <small>A0013952</small>	<b>Enter key</b> <i>In a menu, submenu</i> Opens the operating menu.



### 12.3.2 Calling up remedial measures

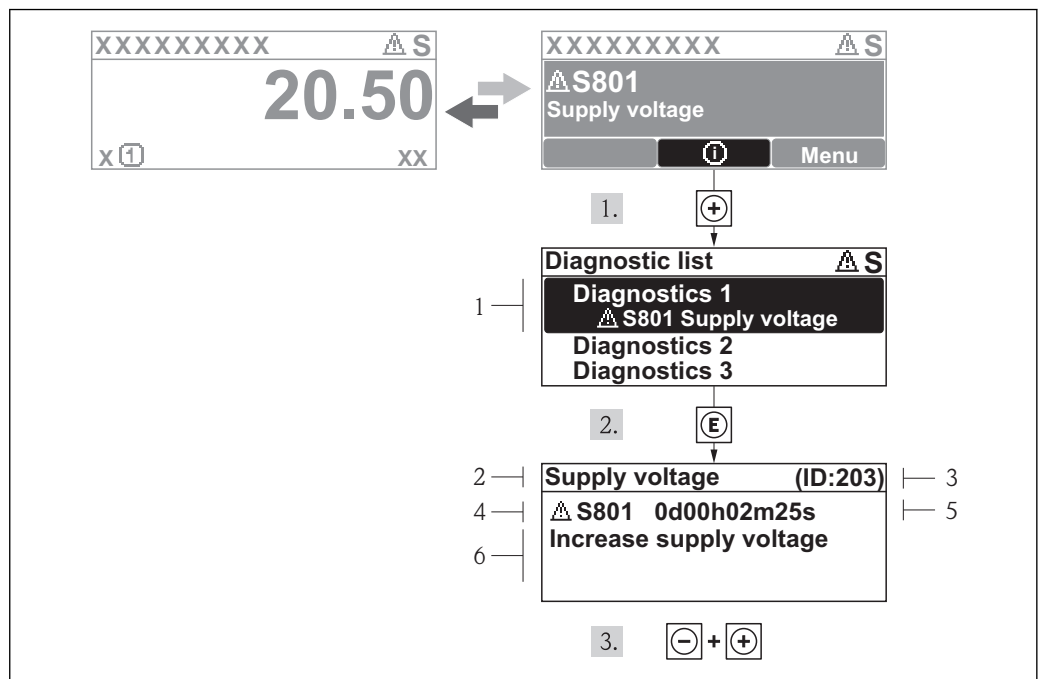

17 Message for remedial measures

- 1 Diagnostic information
- 2 Short text
- 3 Service ID
- 4 Diagnostic behavior with diagnostic code
- 5 Operation time of occurrence
- 6 Remedial measures

The user is in the diagnostic message.

1. Press ⊕ (⊕ symbol).
  - ↳ The **Diagnostic list** submenu opens.
2. Select the desired diagnostic event with ⊕ or ⊖ and press ⊖ .
  - ↳ The message for the remedial measures for the selected diagnostic event opens.
3. Press ⊖ + ⊕ simultaneously.
  - ↳ The message for the remedial measures closes.

The user is in the **Diagnostics** menu at an entry for a diagnostics event, e.g. in the **Diagnostic list** submenu or the **Previous diagnostics** parameter.

1. Press ⊖ .
  - ↳ The message for the remedial measures for the selected diagnostic event opens.
2. Press ⊖ + ⊕ simultaneously.
  - ↳ The message for the remedial measures closes.

## 12.4 Diagnostic information in FieldCare

### 12.4.1 Diagnostic options

Any faults detected by the measuring device are displayed on the home page of the operating tool once the connection has been established.

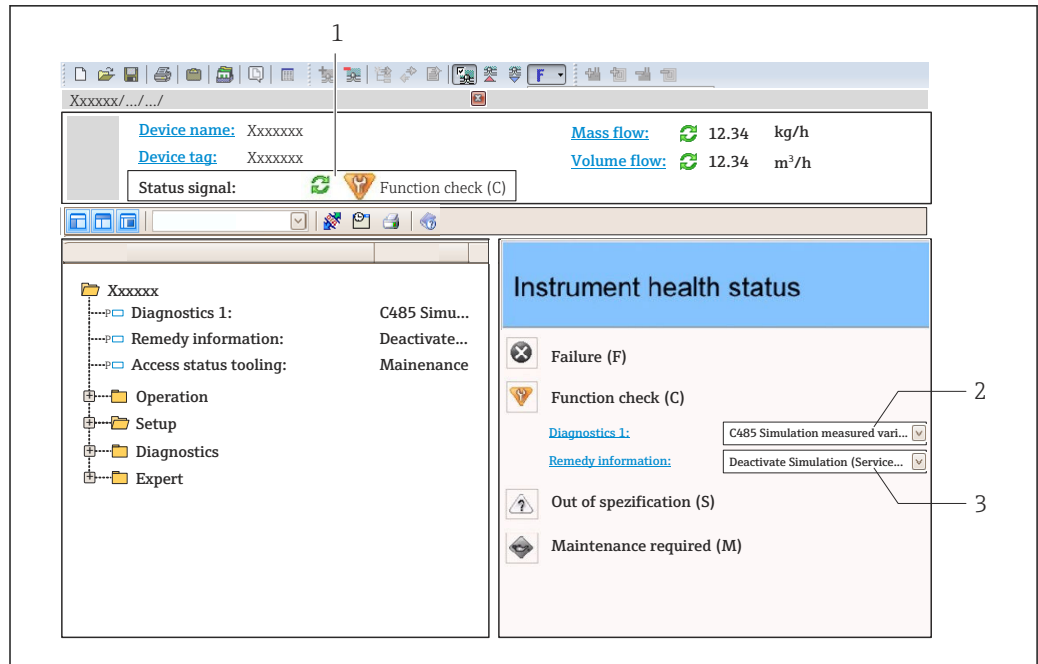

A0021799-EN





- 1 Status area with status signal (→ 79)
- 2 Diagnostic information (→ 80)
- 3 Remedial measures with Service ID

**i** Furthermore, diagnostic events that have occurred can be viewed in the **Diagnostics** menu:

- Via parameters (→ 88)
- Via submenu (→ 89)

### Status signals

The status signals provide information on the state and reliability of the device by categorizing the cause of the diagnostic information (diagnostic event).

Symbol	Meaning
 A0017271	<b>Failure</b> A device error has occurred. The measured value is no longer valid.
 A0017278	<b>Function check</b> The device is in service mode (e.g. during a simulation).
 A0017277	<b>Out of specification</b> The device is operated: Outside its technical specification limits (e.g. outside the process temperature range)
 A0017276	<b>Maintenance required</b> Maintenance is required. The measured value is still valid.

**i** The status signals are categorized in accordance with VDI/VDE 2650 and NAMUR Recommendation NE 107.

### Diagnostic information

The fault can be identified using the diagnostic information. The short text helps you by providing information about the fault.

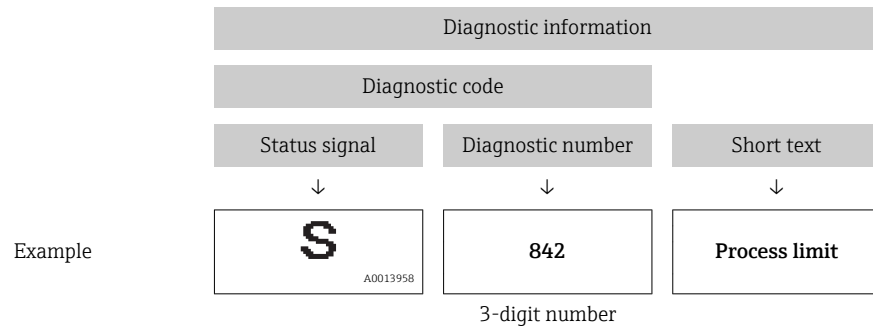

### 12.4.2 Calling up remedy information

Remedy information is provided for every diagnostic event to ensure that problems can be rectified quickly:

- On the home page  
Remedy information is displayed in a separate field below the diagnostics information.
- In the **Diagnostics** menu  
Remedy information can be called up in the working area of the user interface.

The user is in the **Diagnostics** menu.

1. Call up the desired parameter.
2. On the right in the working area, mouse over the parameter.  
↳ A tool tip with remedy information for the diagnostic event appears.

## 12.5 Adapting the diagnostic information

### 12.5.1 Adapting the diagnostic behavior

Each item of diagnostic information is assigned a specific diagnostic behavior at the factory. The user can change this assignment for certain diagnostic information in the **Diagnostic behavior** submenu .

 Diagnostic behavior in accordance with Specification PROFIBUS Profile 3.02, Condensed Status.

"Expert" menu → System → Diagnostic handling → Diagnostic behavior

#### Available diagnostic behaviors

The following diagnostic behaviors can be assigned:

Diagnostic behavior	Description
Alarm	Measurement is interrupted. The totalizers assume the defined alarm condition. A diagnostic message is generated.
Warning	Measurement is resumed. Measured value output via PROFIBUS and totalizers are not affected. A diagnostics message is generated.
Logbook entry only	The device continues to measure. The diagnostic message is entered in the Event logbook (events list) submenu only and is not displayed in alternation with the measured value display.
Off	The diagnostic event is ignored, and no diagnostic message is generated or entered.

### Displaying the measured value status

If the Analog Input, Digital Input and Totalizer function blocks are configured for cyclic data transmission, the device status is coded as per PROFIBUS Profile Specification 3.02 and transmitted along with the measured value to the PROFIBUS Master (Class 1) via the coding byte (byte 5). The coding byte is split into three segments: Quality, Quality Substatus and Limits.

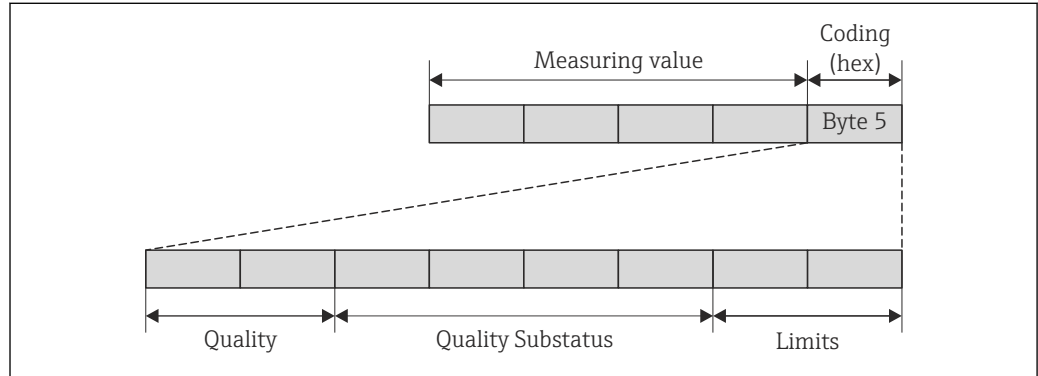

18 Structure of the coding byte

The content of the coding byte depends on the configured failsafe mode in the particular function block. Depending on which failsafe mode has been configured, status information in accordance with PROFIBUS Profile Specification 3.02 is transmitted to the PROFIBUS Master (Class 1) via the coding byte.

### Determining the measured value status and device status via the diagnostic behavior

When the diagnostic behavior is assigned, this also changes the measured value status and device status for the diagnostic information. The measured value status and device status depend on the choice of diagnostic behavior and the group in which the diagnostic information is located. The measured value status and device status are firmly assigned to the particular diagnostic behavior and cannot be changed individually.

The diagnostic information is grouped as follows:

- Diagnostic information pertaining to the sensor: diagnostic number 000 to 199 (→ 84)
- Diagnostic information pertaining to the electronics: diagnostic number 200 to 399 (→ 85)
- Diagnostic information pertaining to the configuration: diagnostic number 400 to 599 (→ 85)
- Diagnostic information pertaining to the process: diagnostic number 800 to 999 (→ 85)

Depending on the group in which diagnostic information is located, the following measured value status and device status are firmly assigned to the particular diagnostic behavior:

*Diagnostic information pertaining to the sensor (diagnostic no.: 000 to 199)*

Diagnostic behavior (configurable)	Measured value status (fixed assignment)				Device diagnostics (fixed assignment)
	Quality	Quality Substatus	Coding (hex)	Category (NE107)	
Alarm	BAD	Maintenance alarm	0x24 to 0x27	F (Failure)	Maintenance alarm
Warning	GOOD	Maintenance demanded	0xA8 to 0xAB	M (Maintenance)	Maintenance demanded

Diagnostic behavior (configurable)	Measured value status (fixed assignment)				Device diagnostics (fixed assignment)
	Quality	Quality Substatus	Coding (hex)	Category (NE107)	
Logbook entry only	GOOD	ok	0x80 to 0x8E	-	-
Off					

Diagnostic information pertaining to the electronics (diagnostic no.: 200 to 399)

Diagnostic behavior (configurable)	Measured value status (fixed assignment)				Device diagnostics (fixed assignment)
	Quality	Quality Substatus	Coding (hex)	Category (NE107)	
Alarm	BAD	Maintenance alarm	0x24 to 0x27	F (Failure)	Maintenance alarm
Warning					
Logbook entry only	GOOD	ok	0x80 to 0x8E	-	-
Off					

Diagnostic information pertaining to the configuration (diagnostic no.: 400 to 599)



Diagnostic behavior (configurable)	Measured value status (fixed assignment)				Device diagnostics (fixed assignment)
	Quality	Quality Substatus	Coding (hex)	Category (NE107)	
Alarm	BAD	Process related	0x28 to 0x2B	F (Failure)	Invalid process condition
Warning	UNCERTAIN	Process related	0x78 to 0x7B	S (Out of specification)	Invalid process condition
Logbook entry only	GOOD	ok	0x80 to 0x8E	-	-
Off					

Diagnostic information pertaining to the process (diagnostic no.: 800 to 999)

Diagnostic behavior (configurable)	Measured value status (fixed assignment)				Device diagnostics (fixed assignment)
	Quality	Quality Substatus	Coding (hex)	Category (NE107)	
Alarm	BAD	Process related	0x28 to 0x2B	F (Failure)	Invalid process condition
Warning	UNCERTAIN	Process related	0x78 to 0x7B	S (Out of specification)	Invalid process condition
Logbook entry only	GOOD	ok	0x80 to 0x8E	-	-
Off					

## 12.6 Overview of diagnostic information

 The amount of diagnostic information and the number of measured variables affected increase if the measuring device has one or more application packages.

 In the case of some items of diagnostic information, the diagnostic behavior can be changed. Adapt the diagnostic information (→  83)

Diagnostic number	Short text	Remedy instructions	Status signal [from the factory]	Diagnostic behavior [from the factory]
<b>Diagnostic of sensor</b>				
022	Sensor temperature	1.Change main electronic module 2.Change sensor	F	Alarm
046	Sensor limit exceeded	1. Inspect sensor 2. Check process condition	S	Warning <sup>1)</sup>
062	Sensor connection	1.Change main electronic module 2.Change sensor	F	Alarm
082	Data storage	1. Check module connections 2. Contact service	F	Alarm
083	Memory content	1. Restart device 2. Contact service	F	Alarm
140	Sensor signal	1.Check or change main electronics 2.Change sensor	S	Alarm <sup>1)</sup>
144	Measuring error too high	1. Check or change sensor 2. Check process conditions	F	Alarm <sup>1)</sup>
190	Special event 1	Contact service	F	Alarm
191	Special event 5	Contact service	F	Alarm
192	Special event 9	Contact service	F	Alarm <sup>1)</sup>
<b>Diagnostic of electronic</b>				
201	Device failure	1. Restart device 2. Contact service	F	Alarm
242	Software incompatible	1. Check software 2. Flash or change main electronics module	F	Alarm
252	Modules incompatible	1. Check electronic modules 2. Change electronic modules	F	Alarm <sup>1)</sup>
262	Module connection	1. Check module connections 2. Change main electronics	F	Alarm
270	Main electronic failure	Change main electronic module	F	Alarm
271	Main electronic failure	1. Restart device 2. Change main electronic module	F	Alarm
272	Main electronic failure	1. Restart device 2. Contact service	F	Alarm
273	Main electronic failure	Change electronic	F	Alarm
274	Main electronic failure	Change electronic	S	Warning <sup>1)</sup>
283	Memory content	1. Reset device 2. Contact service	F	Alarm
311	Electronic failure	1. Reset device 2. Contact service	F	Alarm
311	Electronic failure	1. Do not reset device 2. Contact service	M	Warning
382	Data storage	1. Insert DAT module 2. Change DAT module	F	Alarm
383	Memory content	1. Restart device 2. Check or change DAT module 3. Contact service	F	Alarm
390	Special event 2	Contact service	F	Alarm
391	Special event 6	Contact service	F	Alarm



Diagnostic number	Short text	Remedy instructions	Status signal [from the factory]	Diagnostic behavior [from the factory]
392	Special event 10	Contact service	F	Alarm <sup>1)</sup>
<b>Diagnostic of configuration</b>				
410	Data transfer	1. Check connection 2. Retry data transfer	F	Alarm
411	Up-/download active	Up-/download active, please wait	C	Warning
437	Configuration incompatible	1. Restart device 2. Contact service	F	Alarm
438	Dataset	1. Check data set file 2. Check device configuration 3. Up- and download new configuration	M	Warning
453	Flow override	Deactivate flow override	C	Warning
482	Block in OOS	Set Block in AUTO mode	F	Alarm
484	Simulation failure mode	Deactivate simulation	C	Alarm
485	Simulation measured variable	Deactivate simulation	C	Warning
495	Simulation diagnostic event	Deactivate simulation	C	Warning
497	Simulation block output	Deactivate simulation	C	Warning
537	Configuration	1. Check IP addresses in network 2. Change IP address	F	Warning
590	Special event 3	Contact service	F	Alarm
591	Special event 7	Contact service	F	Alarm
592	Special event 11	Contact service	F	Alarm <sup>1)</sup>
<b>Diagnostic of process</b>				
825	Operating temperature	1. Check ambient temperature 2. Check process temperature	S	Warning
825	Operating temperature	1. Check ambient temperature 2. Check process temperature	F	Alarm
830	Sensor temperature too high	Reduce ambient temp. around the sensor housing	S	Warning
831	Sensor temperature too low	Increase ambient temp. around the sensor housing	S	Warning
832	Electronic temperature too high	Reduce ambient temperature	S	Warning <sup>1)</sup>
833	Electronic temperature too low	Increase ambient temperature	S	Warning <sup>1)</sup>
834	Process temperature too high	Reduce process temperature	S	Warning <sup>1)</sup>
835	Process temperature too low	Increase process temperature	S	Warning <sup>1)</sup>
842	Process limit	Low flow cut off active! 1. Check low flow cut off configuration	S	Warning
843	Process limit	Check process conditions	S	Warning
862	Partly filled pipe	1. Check for gas in process 2. Adjust detection limits	S	Warning

Diagnostic number	Short text	Remedy instructions	Status signal [from the factory]	Diagnostic behavior [from the factory]
882	Input signal	1. Check input configuration 2. Check external device or process conditions	F	Alarm
910	Tubes not oscillating	1. Check electronic 2. Inspect sensor	F	Alarm
912	Medium inhomogeneous	1. Check process cond. 2. Increase system pressure	S	Warning <sup>1)</sup>
912	Inhomogeneous	1. Check process cond. 2. Increase system pressure	S	Warning <sup>1)</sup>
913	Medium unsuitable	1. Check process conditions 2. Check electronic modules or sensor	S	Warning <sup>1)</sup>
944	Monitoring failed	Check process conditions for Heartbeat Monitoring	S	Warning <sup>1)</sup>
948	Tube damping too high	Check process conditions	S	Warning
990	Special event 4	Contact service	F	Alarm
991	Special event 8	Contact service	F	Alarm
992	Special event 12	Contact service	F	Alarm <sup>1)</sup>

1) Diagnostic status is changeable.

## 12.7 Pending diagnostic events

The **Diagnostics** menu allows the user to view the current diagnostic event and the previous diagnostic event separately.

-  To call up the measures to rectify a diagnostic event:
- Via Web browser
  - Via "FieldCare" operating tool (→  83)

-  Other pending diagnostic events can be displayed in the **Diagnostic list** submenu (→  89)

### Navigation

"Diagnostics" menu

### Structure of the submenu

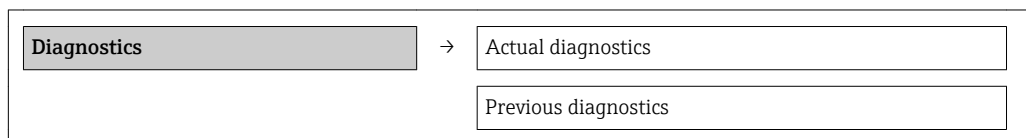



### Parameter overview with brief description

Parameter	Prerequisite	Description	User interface	Factory setting
Actual diagnostics	1 diagnostic event has occurred.	Displays the current diagnostic event along with the diagnostic information.  If two or more messages occur simultaneously, the message with the highest priority is shown on the display.	Symbol for diagnostic behavior, diagnostic code and short message.	–
Previous diagnostics	2 diagnostic events have already occurred.	Displays the diagnostic event that occurred prior to the current diagnostic event along with the diagnostic information.	Symbol for diagnostic behavior, diagnostic code and short message.	–

## 12.8 Diagnostic list

In the **Diagnostic list** submenu, up to 5 currently pending diagnostic events can be displayed along with the related diagnostic information. If more than 5 diagnostic events are pending, the events with the highest priority are shown on the display.

### Navigation path

**Diagnostics** menu → **Diagnostic list** submenu



To call up the measures to rectify a diagnostic event:

- Via Web browser
- Via "FieldCare" operating tool (→  83)

## 12.9 Event logbook

### 12.9.1 Event history

A chronological overview of the event messages that have occurred is provided in the events list which contains a maximum of 20 message entries. This list can be displayed via FieldCare if necessary.



### Navigation path

Event list: **F** → Tool box → Additional functions





For information on the event list, see the FieldCare user interface

This event history includes entries for:

- Diagnostic events (→  85)
- Information events (→  90)

In addition to the operation time of its occurrence and possible troubleshooting measures, each event is also assigned a symbol that indicates whether the event has occurred or is ended:

- Diagnostic event
  - : Event has occurred
  - : Event has ended
- Information event
  - : Event has occurred

A chronological overview of the event messages that have occurred is provided in the **Events list** submenu.

### Navigation path

"Diagnostics" menu → Event logbook → Events list

 To call up the measures to rectify a diagnostic event:

- Via Web browser
- Via "FieldCare" operating tool (→  83)

 For filtering the displayed event messages (→  90)

## 12.9.2 Filtering the event logbook

Using the **Filter options** parameter, you can define which category of event messages is displayed in the **Events list** submenu.

### Navigation path

"Diagnostics" menu → Event logbook → Filter options

### Filter categories

- All
- Failure (F)
- Function check (C)
- Out of specification (S)
- Maintenance required (M)
- Information (I)

## 12.9.3 Overview of information events

Unlike a diagnostic event, an information event is displayed in the event logbook only and not in the diagnostic list.

Info number	Info name
I1000	----- (Device ok)
I1089	Power on
I1090	Configuration reset
I1091	Configuration changed
I1110	Write protection switch changed
I1111	Density adjust failure
I1137	Electronic changed
I1151	History reset
I1155	Reset electronic temperature
I1157	Memory error event list
I1185	Display backup done
I1186	Restore via display done
I1187	Settings downloaded with display
I1188	Display data cleared
I1189	Backup compared
I1209	Density adjustment ok
I1221	Zero point adjust failure
I1222	Zero point adjustment ok
I1256	Display: access status changed
I1264	Safety sequence aborted
I1335	Firmware changed
I1361	Wrong web server login
I1397	Fieldbus: access status changed

Info number	Info name
I1398	CDI: access status changed
I1444	Device verification passed
I1445	Device verification failed
I1446	Device verification active
I1447	Record application reference data
I1448	Application reference data recorded
I1449	Recording application ref. data failed
I1450	Monitoring off
I1451	Monitoring on
I1457	Failed:Measured error verification
I1459	Failed: I/O module verification
I1460	Failed: Sensor integrity verification
I1461	Failed: Sensor verification
I1462	Failed:Sensor electronic module verific.

### 12.10 Resetting the measuring device

Using the **Device reset** parameter it is possible to reset the entire device configuration or some of the configuration to a defined state.

#### Navigation

"Setup" menu → Advanced setup → Administration → Device reset

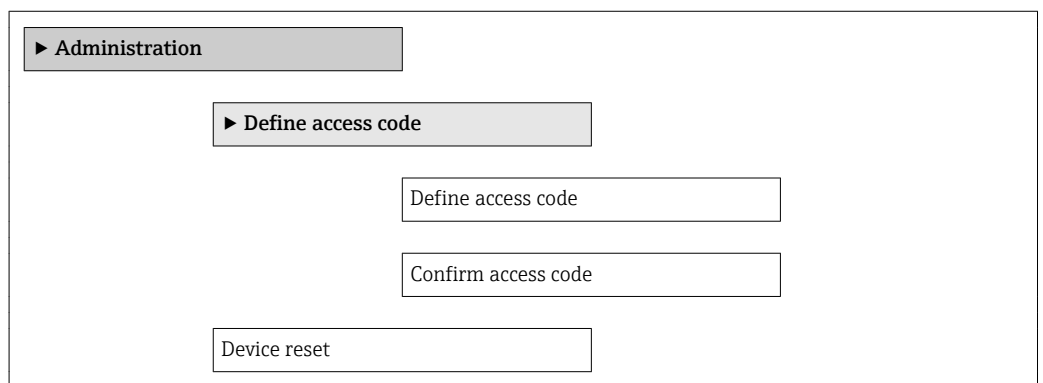

#### Parameter overview with brief description

Parameter	Description	Selection	Factory setting
Device reset	Restart or reset device manually.	<ul style="list-style-type: none"> <li>■ Cancel</li> <li>■ To delivery settings</li> <li>■ Restart device</li> </ul>	Cancel

### 12.10.1 Function scope of "Device reset" parameter

Options	Description
Cancel	No action is executed and the user exits the parameter.
To delivery settings	Every parameter for which a customer-specific default setting was ordered is reset to this customer-specific value. All other parameters are reset to the factory setting.
Restart device	The restart resets every parameter whose data are in the volatile memory (RAM) to the factory setting (e.g. measured value data). The device configuration remains unchanged.
History reset	Every parameter is reset to its factory setting.

## 12.11 Device information

The **Device information** submenu contains all the parameters that display different information for identifying the device.

### Navigation

"Diagnostics" menu → Device information

▶ Device information

### Parameter overview with brief description

Parameter	Description	User interface	Factory setting
Device tag	Enter the name for the measuring point.	Max. 32 characters, such as letters, numbers or special characters (e.g. @, %, /)	Promass 100 DP
Serial number	Displays the serial number of the measuring device.	Max. 11-digit character string comprising letters and numbers.	79AFF16000
Firmware version	Displays the device firmware version installed.	Character string with the following format: xx.yy.zz	01.01
Device name	Displays the name of the transmitter.	Character string composed of letters, numbers and certain punctuation marks.	Promass 100 DP
Order code	Displays the device order code.	Character string composed of letters, numbers and certain punctuation marks	-
Extended order code 1	Displays the 1st part of the extended order code.	Character string	-
Extended order code 2	Displays the 2nd part of the extended order code.	Character string	-
Extended order code 3	Displays the 3rd part of the extended order code.	Character string	-
ENP version	Displays the version of the electronic nameplate.	Character string in the format xx.yy.zz	2.02.00
PROFIBUS ident number	Displays the Profibus identification number.	0 to 65 535	5 473
Status PROFIBUS Master Config	Displays the status of the Profibus Master configuration.	<ul style="list-style-type: none"> <li>■ Active</li> <li>■ Not active</li> </ul>	Not active
IP address	Displays the IP address of the Web server of the measuring device.	4 octet: 0 to 255 (in the particular octet)	192.168.1.212
Subnet mask	Displays the subnet mask.	4 octet: 0 to 255 (in the particular octet)	255.255.255.0
Default gateway	Displays the default gateway.	4 octet: 0 to 255 (in the particular octet)	0.0.0.0

## 12.12 Firmware history

Release date	Firmware version	Order code for "Firmware version"	Firmware changes	Documentation type	Documentation
09.2013	01.00.00	Option 78	Original firmware	Operating Instructions	BA01251D/06/EN/01.13
10.2014	01.01.zz	Option 69	<ul style="list-style-type: none"> <li>■ Integration of optional local display</li> <li>■ New unit "Beer Barrel (BBL)"</li> <li>■ Simulation of diagnostic events</li> </ul>	Operating Instructions	BA01251D/06/EN/02.14

 Flashing the firmware to the current version or to the previous version is possible via the service interface (CDI) .

 For the compatibility of the firmware version with the previous version, the installed device description files and operating tools, observe the information about the device in the "Manufacturer's information" document.

-  The manufacturer's information is available:
- In the Download Area of the Endress+Hauser Internet site: [www.endress.com](http://www.endress.com) → Download
  - Specify the following details:
    - Product root, e.g. 8E1B
    - Text search: Manufacturer's information
    - Search range: documentation

## 13 Maintenance

### 13.1 Maintenance tasks

No special maintenance work is required.

#### 13.1.1 Exterior cleaning

When cleaning the exterior of measuring devices, always use cleaning agents that do not attack the surface of the housing or the seals.

#### 13.1.2 Interior cleaning

Observe the following points for CIP and SIP cleaning:

- Use only cleaning agents to which the process-wetted materials are adequately resistant.
- Observe the maximum permitted medium temperature for the measuring device (→  109).

Observe the following point for cleaning with pigs:

Observe the inside diameter of the measuring tube and process connection.

### 13.2 Measuring and test equipment

Endress+Hauser offers a wide variety of measuring and test equipment, such as W@M or device tests.

 Your Endress+Hauser Sales Center can provide detailed information on the services.

 For a list of some of the measuring and test equipment, refer to the "Accessories" chapter of the "Technical Information" document for the device.

### 13.3 Endress+Hauser services

Endress+Hauser offers a wide variety of services for maintenance such as recalibration, maintenance service or device tests.

 Your Endress+Hauser Sales Center can provide detailed information on the services.

## 14 Repair

### 14.1 General notes

#### Repair and conversion concept

The Endress+Hauser repair and conversion concept provides for the following:

- The measuring devices have a modular design.
- Spare parts are grouped into logical kits with the associated Installation Instructions.
- Repairs are carried out by Endress+Hauser Service or by correspondingly trained customers.
- Certified devices can be converted into other certified devices by Endress+Hauser Service or at the factory only.

#### Notes for repair and conversion



For repair and modification of a measuring device, observe the following notes:

- Use only original Endress+Hauser spare parts.
- Carry out the repair according to the Installation Instructions.
- Observe the applicable standards, federal/national regulations, Ex documentation (XA) and certificates.
- Document every repair and each conversion and enter them into the *W@M* life cycle management database.

### 14.2 Spare parts

*W@M Device Viewer* ([www.endress.com/deviceviewer](http://www.endress.com/deviceviewer)):

All the spare parts for the measuring device, along with the order code, are listed here and can be ordered. If available, users can also download the associated Installation Instructions.

-  Measuring device serial number:
  - Is located on the nameplate of the device.
  - Can be read out via the **Serial number** parameter in the **Device information** submenu (→  92).

### 14.3 Endress+Hauser services

-  Contact your Endress+Hauser Sales Center for information on services and spare parts.

### 14.4 Return

The measuring device must be returned if it is need of repair or a factory calibration, or if the wrong measuring device has been delivered or ordered. Legal specifications require Endress+Hauser, as an ISO-certified company, to follow certain procedures when handling products that are in contact with the medium.

To ensure safe, swift and professional device returns, please refer to the procedure and conditions for returning devices provided on the Endress+Hauser website at <http://www.endress.com/support/return-material>

### 14.5 Disposal

#### 14.5.1 Removing the measuring device

1. Switch off the device.



2. **WARNING!** Danger to persons from process conditions. Beware of hazardous process conditions such as pressure in the measuring device, high temperatures or aggressive fluids.

Carry out the mounting and connection steps from the chapters "Mounting the measuring device" and "Connecting the measuring device" in the logically reverse sequence. Observe the safety instructions.

### 14.5.2 Disposing of the measuring device

**⚠ WARNING**

**Danger to personnel and environment from fluids that are hazardous to health.**

- ▶ Ensure that the measuring device and all cavities are free of fluid residues that are hazardous to health or the environment, e.g. substances that have permeated into crevices or diffused through plastic.

Observe the following notes during disposal:

- Observe valid federal/national regulations.
- Ensure proper separation and reuse of the device components.

## 15 Accessories

Various accessories, which can be ordered with the device or subsequently from Endress+Hauser, are available for the device. Detailed information on the order code in question is available from your local Endress+Hauser sales center or on the product page of the Endress+Hauser website: [www.endress.com](http://www.endress.com).

### 15.1 Device-specific accessories



#### 15.1.1 For the sensor

Accessories	Description
Heating jacket	<p>Is used to stabilize the temperature of the fluids in the sensor. Water, water vapor and other non-corrosive liquids are permitted for use as fluids. If using oil as a heating medium, please consult with Endress+Hauser.</p> <p> For details, see Operating Instructions BA00099D</p>

### 15.2 Service-specific accessories

Accessories	Description
Applicator	<p>Software for selecting and sizing Endress+Hauser measuring devices:</p> <ul style="list-style-type: none"> <li>■ Calculation of all the necessary data for identifying the optimum flowmeter: e.g. nominal diameter, pressure loss, accuracy or process connections.</li> <li>■ Graphic illustration of the calculation results</li> </ul> <p>Administration, documentation and access to all project-related data and parameters throughout the entire life cycle of a project.</p> <p>Applicator is available:</p> <ul style="list-style-type: none"> <li>■ Via the Internet: <a href="https://wapps.endress.com/applicator">https://wapps.endress.com/applicator</a></li> <li>■ On CD-ROM for local PC installation.</li> </ul>
W@M	<p>Life cycle management for your plant</p> <p>W@M supports you with a wide range of software applications over the entire process: from planning and procurement, to the installation, commissioning and operation of the measuring devices. All the relevant device information, such as the device status, spare parts and device-specific documentation, is available for every device over the entire life cycle.</p> <p>The application already contains the data of your Endress+Hauser device. Endress+Hauser also takes care of maintaining and updating the data records.</p> <p>W@M is available:</p> <ul style="list-style-type: none"> <li>■ Via the Internet: <a href="http://www.endress.com/lifecyclemanagement">www.endress.com/lifecyclemanagement</a></li> <li>■ On CD-ROM for local PC installation.</li> </ul>
FieldCare	<p>FDT-based plant asset management tool from Endress+Hauser.</p> <p>It can configure all smart field units in your system and helps you manage them. By using the status information, it is also a simple but effective way of checking their status and condition.</p> <p> For details, see Operating Instructions BA00027S and BA00059S</p>

## 15.3 System components

Accessories	Description
Memograph M graphic display recorder	<p>The Memograph M graphic display recorder provides information on all relevant measured variables. Measured values are recorded correctly, limit values are monitored and measuring points analyzed. The data are stored in the 256 MB internal memory and also on a SD card or USB stick.</p> <p> For details, see "Technical Information" TI00133R and Operating Instructions BA00247R</p>
iTEMP	<p>The temperature transmitters can be used in all applications and are suitable for the measurement of gases, steam and liquids. They can be used to read in the fluid temperature.</p> <p> For details, see "Fields of Activity", FA00006T</p>

## 16 Technical data

### 16.1 Application

The measuring device is suitable for flow measurement of liquids and gases only.

Depending on the version ordered, the measuring device can also measure potentially explosive, flammable, poisonous and oxidizing media.

To ensure that the device remains in proper operating condition for its service life, use the measuring device only for media against which the process-wetted materials are adequately resistant.

### 16.2 Function and system design

Measuring principle      Mass flow measurement based on the Coriolis measuring principle

Measuring system      The device consists of a transmitter and a sensor.  
 One device version is available: compact version - transmitter and sensor form a mechanical unit.  
 For information on the structure of the device (→  12)

### 16.3 Input

Measured variable      **Direct measured variables**

- Mass flow
- Density
- Temperature
- Viscosity

**Calculated measured variables**

- Volume flow
- Corrected volume flow
- Reference density

Measuring range      **Measuring ranges for liquids**

DN		Measuring range full scale values $\dot{m}_{\min(F)}$ to $\dot{m}_{\max(F)}$	
[mm]	[in]	[kg/h]	[lb/min]
8	$\frac{3}{8}$	0 to 2 000	0 to 73.50
15	$\frac{1}{2}$	0 to 6 500	0 to 238.9
15 FB	$\frac{1}{2}$ FB	0 to 18 000	0 to 661.5
25	1	0 to 18 000	0 to 661.5
25 FB	1 FB	0 to 45 000	0 to 1 654
40	$1\frac{1}{2}$	0 to 45 000	0 to 1 654
40 FB	$1\frac{1}{2}$ FB	0 to 70 000	0 to 2 573
50	2	0 to 70 000	0 to 2 573

DN		Measuring range full scale values $\dot{m}_{\min(F)}$ to $\dot{m}_{\max(F)}$	
[mm]	[in]	[kg/h]	[lb/min]
50 FB	2 FB	0 to 180 000	0 to 6 615
80	3	0 to 180 000	0 to 6 615

FB = Full bore

### Measuring ranges for gases

The full scale values depend on the density of the gas and can be calculated with the formula below:

$$\dot{m}_{\max(G)} = \dot{m}_{\max(F)} \cdot \rho_G : x$$

$\dot{m}_{\max(G)}$	Maximum full scale value for gas [kg/h]
$\dot{m}_{\max(F)}$	Maximum full scale value for liquid [kg/h]
$\dot{m}_{\max(G)} < \dot{m}_{\max(F)}$	$\dot{m}_{\max(G)}$ can never be greater than $\dot{m}_{\max(F)}$
$\rho_G$	Gas density in [kg/m <sup>3</sup> ] at operating conditions

DN		x
[mm]	[in]	[kg/m <sup>3</sup> ]
8	$\frac{3}{8}$	60
15	$\frac{1}{2}$	80
15 FB	$\frac{1}{2}$ FB	90
25	1	90
25 FB	1 FB	90
40	$1\frac{1}{2}$	90
40 FB	$1\frac{1}{2}$ FB	90
50	2	90
50 FB	2 FB	110
80	3	110

FB = Full bore

### Calculation example for gas

- Sensor: Promass I, DN 50
- Gas: Air with a density of 60.3 kg/m<sup>3</sup> (at 20 °C and 50 bar)
- Measuring range (liquid): 70 000 kg/h
- x = 90 kg/m<sup>3</sup> (for Promass I, DN 50)

Maximum possible full scale value:

$$\dot{m}_{\max(G)} = \dot{m}_{\max(F)} \cdot \rho_G : x = 70\,000 \text{ kg/h} \cdot 60.3 \text{ kg/m}^3 : 90 \text{ kg/m}^3 = 46\,900 \text{ kg/h}$$

### Recommended measuring range

"Flow limit" section (→  110)

Operable flow range

Over 1000 : 1.

Flow rates above the preset full scale value are not overridden by the electronics unit, with the result that the totalizer values are registered correctly.

## 16.4 Output

Output signal

**PROFIBUS DP**

Signal encoding	NRZ code
Data transfer	9.6 kBaud...12 MBaud

Signal on alarm

Depending on the interface, failure information is displayed as follows:

**PROFIBUS DP**

Status and alarm messages	Diagnostics in accordance with PROFIBUS PA Profile 3.02
---------------------------	---

**Local display**

Plain text display	With information on cause and remedial measures
Backlight	Red backlighting indicates a device error.

 Status signal as per NAMUR recommendation NE 107

**Operating tool**

- Via digital communication:  
PROFIBUS DP
- Via service interface

Plain text display	With information on cause and remedial measures
--------------------	---

**Web browser**

Plain text display	With information on cause and remedial measures
--------------------	---

Low flow cut off

The switch points for low flow cut off are user-selectable.

Galvanic isolation

The following connections are galvanically isolated from each other:

- Outputs
- Power supply

Protocol-specific data

**PROFIBUS DP**

Manufacturer ID	0x11
Ident number	0x1561
Profile version	3.02
Device description files (GSD, DTM, DD)	Information and files under: <ul style="list-style-type: none"> <li>■ <a href="http://www.endress.com">www.endress.com</a> On the product page for the device: Documents/Software → Device drivers</li> <li>■ <a href="http://www.profibus.org">www.profibus.org</a></li> </ul>

<p><b>Output values</b> (from measuring device to automation system)</p>	<p><b>Analog input 1 to 8</b></p> <ul style="list-style-type: none"> <li>▪ Mass flow</li> <li>▪ Volume flow</li> <li>▪ Corrected volume flow</li> <li>▪ Target mass flow</li> <li>▪ Carrier mass flow</li> <li>▪ Density</li> <li>▪ Reference density</li> <li>▪ Concentration</li> <li>▪ Dynamic viscosity</li> <li>▪ Kinematic viscosity</li> <li>▪ Temp. compensated dynamic viscosity</li> <li>▪ Temp. compensated kinematic viscosity</li> <li>▪ Temperature</li> <li>▪ Carrier pipe temperature</li> <li>▪ Electronic temperature</li> <li>▪ Oscillation frequency</li> <li>▪ Oscillation amplitude</li> <li>▪ Frequency fluctuation</li> <li>▪ Oscillation damping</li> <li>▪ Tube damping fluctuation</li> <li>▪ Signal asymmetry</li> <li>▪ Exciter current</li> </ul> <p><b>Digital input 1 to 2</b></p> <ul style="list-style-type: none"> <li>▪ Partially filled pipe detection</li> <li>▪ Low flow cut off</li> </ul> <p><b>Totalizer 1 to 3</b></p> <ul style="list-style-type: none"> <li>▪ Mass flow</li> <li>▪ Volume flow</li> <li>▪ Corrected volume flow</li> </ul>
<p><b>Input values</b> (from automation system to measuring device)</p>	<p><b>Analog output 1 to 3 (fixed assignment)</b></p> <ul style="list-style-type: none"> <li>▪ Pressure</li> <li>▪ Temperature</li> <li>▪ Reference density</li> </ul> <p><b>Digital output 1 to 3 (fixed assignment)</b></p> <ul style="list-style-type: none"> <li>▪ Digital output 1: switch positive zero return on/off</li> <li>▪ Digital output 2: perform zero point adjustment</li> <li>▪ Digital output 3: switch switch output on/off</li> </ul> <p><b>Totalizer 1 to 3</b></p> <ul style="list-style-type: none"> <li>▪ Totalize</li> <li>▪ Reset and hold</li> <li>▪ Preset and hold</li> <li>▪ Stop</li> <li>▪ Operating mode configuration:                         <ul style="list-style-type: none"> <li>– Net flow total</li> <li>– Forward flow total</li> <li>– Reverse flow total</li> </ul> </li> </ul>
<p><b>Supported functions</b></p>	<ul style="list-style-type: none"> <li>▪ Identification &amp; Maintenance Simplest device identification on the part of the control system and nameplate</li> <li>▪ PROFIBUS upload/download Reading and writing parameters is up to ten times faster with PROFIBUS upload/download</li> <li>▪ Condensed status Simplest and self-explanatory diagnostic information by categorizing diagnostic messages that occur</li> </ul>
<p><b>Configuration of the device address</b></p>	<ul style="list-style-type: none"> <li>▪ DIP switches on the I/O electronics module</li> <li>▪ Via operating tools (e.g. FieldCare)</li> </ul>

## 16.5 Power supply

Pin assignment, device plug (→  31)

Supply voltage The power unit must be tested to ensure it meets safety requirements (e.g. PELV, SELV).

**Transmitter**  
DC 20 to 30 V

Power consumption **Transmitter**

Order code for "Output"	Maximum Power consumption
Option L: PROFIBUS DP	3.5 W

Current consumption **Transmitter**

Order code for "Output"	Maximum Current consumption	Maximum switch-on current
Option L: PROFIBUS DP	145 mA	18 A (<0.125 ms)

Power supply failure

- Totalizers stop at the last value measured.
- Depending on the device version, the configuration is retained in the device memory or in the plug-in memory (HistoROM DAT).
- Error messages (incl. total operated hours) are stored.

Electrical connection (→  31)

Potential equalization (→  33)

Terminals **Transmitter**  
Spring terminals for wire cross-sections 0.5 to 2.5 mm<sup>2</sup> (20 to 14 AWG)

Cable entries



- Cable gland: M20 × 1.5 with cable  $\phi$ 6 to 12 mm (0.24 to 0.47 in)
- Thread for cable entry:
  - NPT 1/2"
  - G 1/2"
  - M20

Cable specification (→  29)

## 16.6 Performance characteristics

Reference operating conditions

- Error limits based on ISO 11631
- Water with +15 to +45 °C (+59 to +113 °F) at 2 to 6 bar (29 to 87 psi)
- Specifications as per calibration protocol
- Accuracy based on accredited calibration rigs that are traced to ISO 17025.

 To obtain measured errors, use the *Applicator* sizing tool (→  98)(→  119)



Maximum measured error o.r. = of reading;  $1 \text{ g/cm}^3 = 1 \text{ kg/l}$ ; T = medium temperature

### Base accuracy

#### Mass flow and volume flow (liquids)

$\pm 0.10 \%$

#### Mass flow (gases)

$\pm 0.50 \%$  o.r.

 Design fundamentals ([→](#)  107)

### Density (liquids)

- Reference conditions:  $\pm 0.0005 \text{ g/cm}^3$
- Standard density calibration:  $\pm 0.02 \text{ g/cm}^3$   
(valid over the entire temperature range and density range)
- Wide-range density specification (order code for "Application package", option EF "Special density and concentration" or EH "Special density and viscosity"):  $\pm 0.004 \text{ g/cm}^3$  (valid range for special density calibration:  $0 \text{ to } 2 \text{ g/cm}^3$ ,  $+10 \text{ to } +80 \text{ }^\circ\text{C}$  ( $+50 \text{ to } +176 \text{ }^\circ\text{F}$ ))

### Temperature

$\pm 0.5 \text{ }^\circ\text{C} \pm 0.005 \cdot T \text{ }^\circ\text{C}$  ( $\pm 0.9 \text{ }^\circ\text{F} \pm 0.003 \cdot (T - 32) \text{ }^\circ\text{F}$ )

### Zero point stability

DN		Zero point stability	
[mm]	[in]	[kg/h]	[lb/min]
8	$\frac{3}{8}$	0.150	0.0055
15	$\frac{1}{2}$	0.488	0.0179
15 FB	$\frac{1}{2}$ FB	1.350	0.0496
25	1	1.350	0.0496
25 FB	1 FB	3.375	0.124
40	$1\frac{1}{2}$	3.375	0.124
40 FB	$1\frac{1}{2}$ FB	5.25	0.193
50	2	5.25	0.193
50 FB	2 FB	13.5	0.496
80	3	13.5	0.496

FB = Full bore

### Flow values

Flow values as turndown parameter depending on nominal diameter.

#### SI units

DN [mm]	1:1	1:10	1:20	1:50	1:100	1:500
	[kg/h]	[kg/h]	[kg/h]	[kg/h]	[kg/h]	[kg/h]
8	2 000	200	100	40	20	4
15	6 500	650	325	130	65	13
15 FB	18 000	1 800	900	360	180	36
25	18 000	1 800	900	360	180	36
25 FB	45 000	4 500	2 250	900	450	90
40	45 000	4 500	2 250	900	450	90

DN	1:1	1:10	1:20	1:50	1:100	1:500
[mm]	[kg/h]	[kg/h]	[kg/h]	[kg/h]	[kg/h]	[kg/h]
40 FB	70000	7000	3500	1400	700	140
50	70000	7000	3500	1400	700	140
50 FB	180000	18000	9000	3600	1800	360
80	180000	18000	9000	3600	1800	360

FB = Full bore

*US units*

DN	1:1	1:10	1:20	1:50	1:100	1:500
[inch]	[lb/min]	[lb/min]	[lb/min]	[lb/min]	[lb/min]	[lb/min]
$\frac{3}{8}$	73.50	7.350	3.675	1.470	0.735	0.147
$\frac{1}{2}$	238.9	23.89	11.95	4.778	2.389	0.478
$\frac{1}{2}$ FB	661.5	66.15	33.08	13.23	6.615	1.323
1	661.5	66.15	33.08	13.23	6.615	1.323
1 FB	1654	165.4	82.70	33.08	16.54	3.308
$1\frac{1}{2}$	1654	165.4	82.70	33.08	16.54	3.308
$1\frac{1}{2}$ FB	2573	257.3	128.7	51.46	25.73	5.146
2	2573	257.3	128.7	51.46	25.73	5.146
2 FB	6615	661.5	330.8	132.3	66.15	13.23
3	6615	661.5	330.8	132.3	66.15	13.23

FB = Full bore

Repeatability

o.r. = of reading;  $1 \text{ g/cm}^3 = 1 \text{ kg/l}$ ; T = medium temperature

**Base repeatability**

**Mass flow and volume flow (liquids)**

$\pm 0.05 \%$  o.r.

**Mass flow (gases)**

$\pm 0.25 \%$  o.r.

 Design fundamentals ( $\rightarrow$   107)

**Density (liquids)**

$\pm 0.00025 \text{ g/cm}^3$

**Temperature**

$\pm 0.25 \text{ }^\circ\text{C} \pm 0.0025 \cdot T \text{ }^\circ\text{C}$  ( $\pm 0.45 \text{ }^\circ\text{F} \pm 0.0015 \cdot (T-32) \text{ }^\circ\text{F}$ )

Response time

The response time depends on the configuration (damping).

Influence of medium temperature

**Mass flow and volume flow**

When there is a difference between the temperature for zero point adjustment and the process temperature, the typical measured error of the sensor is  $\pm 0.0002 \%$  of the full scale value/ $^\circ\text{C}$  ( $\pm 0.0001 \%$  of the full scale value/ $^\circ\text{F}$ ).

**Density**

When there is a difference between the density calibration temperature and the process temperature, the typical measured error of the sensor is  $\pm 0.0001 \text{ g/cm}^3 / ^\circ\text{C}$  ( $\pm 0.00005 \text{ g/cm}^3 / ^\circ\text{F}$ ). Field density calibration is possible.

**Wide-range density specification (special density calibration)**

If the process temperature is outside the valid range ( $\rightarrow$   105) the measured error is  $\pm 0.0001 \text{ g/cm}^3 / ^\circ\text{C}$  ( $\pm 0.00005 \text{ g/cm}^3 / ^\circ\text{F}$ )

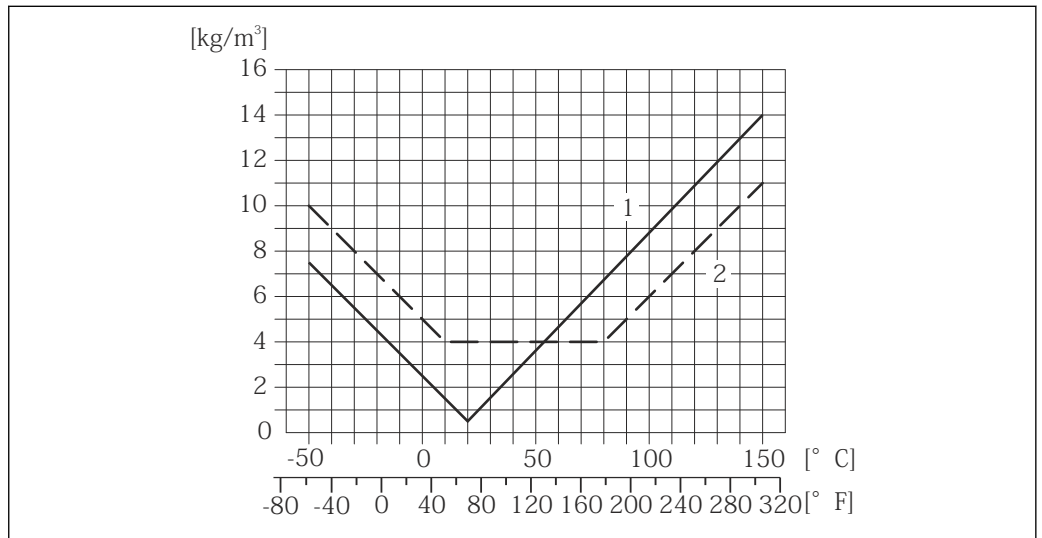

A0016614

- 1 Field density calibration, for example at +20 °C (+68 °F)
- 2 Special density calibration

**Temperature**

$\pm 0.005 \cdot T \text{ } ^\circ\text{C}$  ( $\pm 0.005 \cdot (T - 32) \text{ } ^\circ\text{F}$ )

Influence of medium pressure

The table below shows the effect on accuracy of mass flow due to a difference between calibration pressure and process pressure.

o.r. = of reading

DN		[% o.r./bar]	[% o.r./psi]
[mm]	[in]		
8	$\frac{3}{8}$	No effect	No effect
15	$\frac{1}{2}$	No effect	No effect
15 FB	$\frac{1}{2}$ FB	-0.003	-0.0002
25	1	-0.003	-0.0002
25 FB	1 FB	No effect	No effect
40	$1\frac{1}{2}$	No effect	No effect
40 FB	$1\frac{1}{2}$ FB	No effect	No effect
50	2	No effect	No effect
50 FB	2 FB	-0.003	-0.0002
80	3	No effect	No effect
FB = Full bore			

Design fundamentals

o.r. = of reading, o.f.s. = of full scale value

BaseAccu = base accuracy in % o.r., BaseRepeat = base repeatability in % o.r.

MeasValue = measured value; ZeroPoint = zero point stability

*Calculation of the maximum measured error as a function of the flow rate*

Flow rate	Maximum measured error in % o.r.
$\geq \frac{\text{ZeroPoint}}{\text{BaseAccu}} \cdot 100$ <small>A0021332</small>	$\pm \text{BaseAccu}$ <small>A0021339</small>
$< \frac{\text{ZeroPoint}}{\text{BaseAccu}} \cdot 100$ <small>A0021333</small>	$\pm \frac{\text{ZeroPoint}}{\text{MeasValue}} \cdot 100$ <small>A0021334</small>

*Calculation of the maximum repeatability as a function of the flow rate*

Flow rate	Maximum repeatability in % o.r.
$\geq \frac{1/2 \cdot \text{ZeroPoint}}{\text{BaseRepeat}} \cdot 100$ <small>A0021335</small>	$\pm \text{BaseRepeat}$ <small>A0021340</small>
$< \frac{1/2 \cdot \text{ZeroPoint}}{\text{BaseRepeat}} \cdot 100$ <small>A0021336</small>	$\pm 1/2 \cdot \frac{\text{ZeroPoint}}{\text{MeasValue}} \cdot 100$ <small>A0021337</small>

**Example for max. measured error**

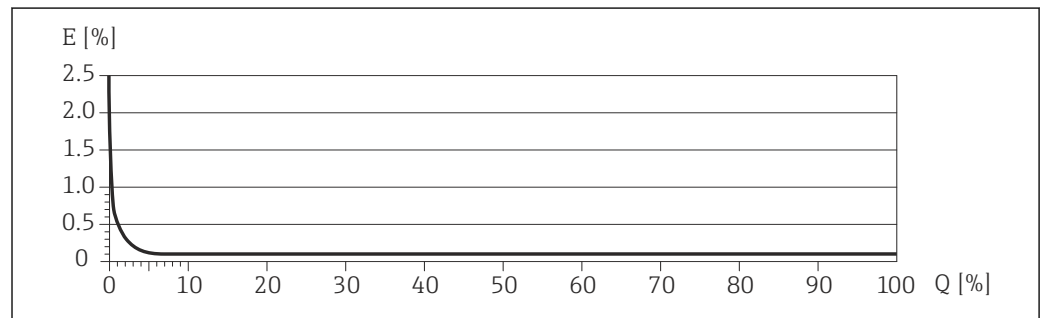

E Error: Maximum measured error as % o.r. (example)  
Q Flow rate as %

**i** Design fundamentals (→ 107)

## 16.7 Installation

"Mounting requirements" (→ 19)



## 16.8 Environment

Ambient temperature range (→ 21)

### Temperature tables

**i** Observe the interdependencies between the permitted ambient and fluid temperatures when operating the device in hazardous areas.

 For detailed information on the temperature tables, see the separate document entitled "Safety Instructions" (XA) for the device.

Storage temperature	<p>All components apart from the display modules:</p> <ul style="list-style-type: none"> <li>■ -40 to +80 °C (-40 to +176 °F), preferably at +20 °C (+68 °F) (standard version)</li> <li>■ -50 to +80 °C (-58 to +176 °F) (Order code for "Test, certificate", option JM)</li> </ul> <p><b>Display modules</b></p> <p>-40 to +80 °C (-40 to +176 °F)</p>
Climate class	DIN EN 60068-2-38 (test Z/AD)
Degree of protection	<p><b>Transmitter and sensor</b></p> <ul style="list-style-type: none"> <li>■ As standard: IP66/67, type 4X enclosure</li> <li>■ With the order code for "Sensor options", option <b>CM</b>: IP69K can also be ordered</li> <li>■ When housing is open: IP20, type 1 enclosure</li> <li>■ Display module: IP20, type 1 enclosure</li> </ul>
Shock resistance	As per IEC/EN 60068-2-31
Vibration resistance	Acceleration up to 1 g, 10 to 150 Hz, based on IEC/EN 60068-2-6
Interior cleaning	<ul style="list-style-type: none"> <li>■ Sterilization in place (SIP)</li> <li>■ Cleaning in place (CIP)</li> <li>■ Cleaning with pigs</li> </ul>
Electromagnetic compatibility (EMC)	<ul style="list-style-type: none"> <li>■ As per IEC/EN 61326 and NAMUR Recommendation 21 (NE 21)</li> <li>■ Complies with emission limits for industry as per EN 55011 (Class A)</li> <li>■ Device version with PROFIBUS DP: Complies with emission limits for industry as per EN 50170 Volume 2, IEC 61784</li> </ul> <p> The following applies for PROFIBUS DP: If baud rates &gt; 1.5 MBaud an EMC cable entry must be used and the cable shield must continue as far as the terminal wherever possible.</p> <p> For details refer to the Declaration of Conformity.</p>
<b>16.9 Process</b>	
Medium temperature range	<p><b>Sensor</b></p> <p>-50 to +150 °C (-58 to +302 °F)</p> <p><b>Seals</b></p> <p>No internal seals</p>
Density	0 to 5 000 kg/m <sup>3</sup> (0 to 312 lb/cf)
Pressure-temperature ratings	<p> An overview of the pressure-temperature ratings for the process connections is provided in the "Technical Information" document</p>

Secondary containment pressure rating

The sensor housing is filled with dry nitrogen and protects the electronics and mechanics inside.

The following secondary containment pressure rating is only valid for a fully welded sensor housing and/or a device equipped with closed purge connections (never opened/as delivered).

DN		Secondary containment pressure rating (designed with a safety factor $\geq 4$ )		Secondary containment burst pressure	
[mm]	[in]	[bar]	[psi]	[bar]	[psi]
8	$\frac{3}{8}$	40	580	220	3190
15	$\frac{1}{2}$	40	580	220	3190
15 FB	$\frac{1}{2}$ FB	40	580	235	3405
25	1	40	580	235	3405
25 FB	1 FB	40	580	220	3190
40	$1\frac{1}{2}$	40	580	220	3190
40 FB	$1\frac{1}{2}$ FB	40	580	235	3405
50	2	40	580	235	3405
50 FB	2 FB	40	580	460	6670
80	3	40	580	460	6670
FB = Full bore					

 If there is a risk of measuring tube failure due to process characteristics, e.g. with corrosive fluids, we recommend the use of sensors whose secondary containment is equipped with special pressure monitoring connections (order code for "Sensor option", option CH "Purge connection").

With the help of these connections, the fluid collected in the secondary containment can be bled off in the event of tube failure. This is especially important in high-pressure gas applications. These connections can also be used for gas purging (gas detection).

Do not open the purge connections unless the containment can be filled immediately with a dry, inert gas. Use only low gauge pressure to purge. Maximum pressure: 5 bar (72.5 psi).

If a device fitted with purge connections is connected to the purge system, the maximum nominal pressure is determined by the purge system itself or by the device, depending on which component has the lower nominal pressure.

 For the dimensions and installation lengths of the device, see the "Technical Information" document, "Mechanical construction" section

Flow limit

Select the nominal diameter by optimizing between the required flow range and permissible pressure loss.

 For an overview of the measuring range full scale values, see the "Measuring range" section ( $\rightarrow$   100)

- The minimum recommended full scale value is approx. 1/20 of the maximum full scale value
- In most applications, 20 to 50 % of the maximum full scale value can be considered ideal
- A low full scale value must be selected for abrasive media (such as liquids with entrained solids): flow velocity < 1 m/s (< 3 ft/s).
- For gas measurement the following rules apply:
  - The flow velocity in the measuring tubes should not exceed half the sonic velocity (0.5 Mach).
  - The maximum mass flow depends on the density of the gas: formula (→  101)

---

**Pressure loss**

To calculate the pressure loss, use the *Applicator* sizing tool (→  119)

## 16.10 Mechanical construction

Design, dimensions



For the dimensions and installation lengths of the device, see the "Technical Information" document, "Mechanical construction" section

Weight

### Compact version

#### Weight in SI units

All values (weight) refer to devices with EN/DIN PN 40 flanges. Weight information in [kg].

DN [mm]	Weight [kg]
8	11
15	13
15 FB	19
25	20
25 FB	39
40	40
40 FB	65
50	67
50 FB	118
80	122
FB = Full bore	

#### Weight in US units

All values (weight) refer to devices with EN/DIN PN 40 flanges. Weight information in [lbs].

DN [in]	Weight [lbs]
3/8	24
1/2	29
1/2 FB	42
1	44
1 FB	86
1 1/2	88
1 1/2 FB	143
2	148
2 FB	260
3	269
FB = Full bore	



Materials

**Transmitter housing**

- Order code for "Housing", option **A** "Compact, aluminum coated":  
Aluminum, AlSi10Mg, coated
- Order code for "Housing", option **B** "Compact, hygienic, stainless":  
Hygienic version, stainless steel 1.4301 (304)
- Order code for "Housing", option **C** "Ultra-compact, hygienic, stainless":  
Hygienic version, stainless steel 1.4301 (304)

**Cable entries/cable glands**

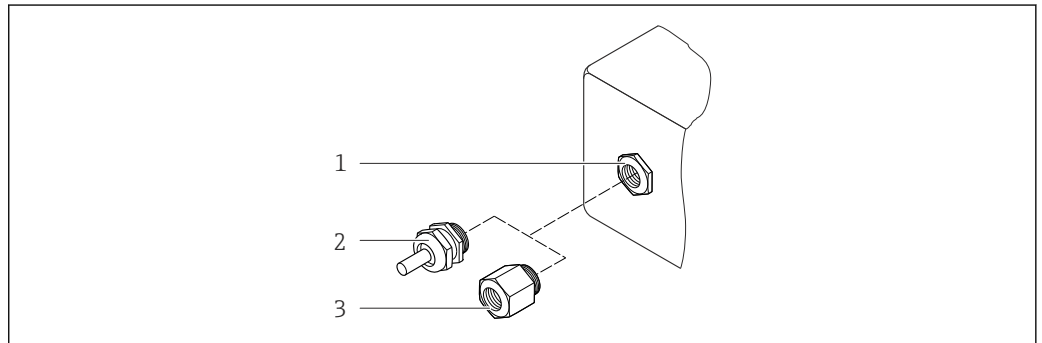

19 Possible cable entries/cable glands

- 1 Cable entry in transmitter housing, wall-mount housing or connection housing with internal thread M20 x 1.5
- 2 Cable gland M20 x 1.5
- 3 Adapter for cable entry with internal thread G ½" or NPT ½"

*Order Code for "Housing", Option A "Compact, coated aluminum"*

The various cable entries are suitable for hazardous and non-hazardous areas.

Cable entry/cable gland	Material
Cable gland M20 x 1.5	Nickel-plated brass
Adapter for cable entry with internal thread G ½"	
Adapter for cable entry with internal thread NPT ½"	

*Order code for "Housing", option B "Compact, hygienic, stainless"*

The various cable entries are suitable for hazardous and non-hazardous areas.

Cable entry/cable gland	Material
Cable gland M20 x 1.5	Stainless steel, 1.4404 (316L)
Adapter for cable entry with internal thread G ½"	
Adapter for cable entry with internal thread NPT ½"	

**Device plug**

Electrical connection	Material
Plug M12x1	<ul style="list-style-type: none"> <li>■ Socket: Stainless steel, 1.4404 (316L)</li> <li>■ Contact housing: Polyamide</li> <li>■ Contacts: Gold-plated brass</li> </ul>

**Sensor housing**

- Acid and alkali-resistant outer surface
- Stainless steel 1.4301 (304)

**Measuring tubes**

Grade 9 titanium

**Process connections**

- Flanges according to EN 1092-1 (DIN 2501) / according to ASME B16.5/ according to JIS:
  - Stainless steel 1.4301 (304)
  - Wetted parts: Grade 2 titanium
- All other process connections:
  - Grade 2 titanium



List of all available process connections (→ 114)

**Surface quality (parts in contact with medium)**

- Not polished
- $Ra_{max} = 0.8 \mu\text{m}$  (32  $\mu\text{in}$ )
- $Ra_{max} = 0.4 \mu\text{m}$  (16  $\mu\text{in}$ )

**Seals**

Welded process connections without internal seals

**Process connections**

- Flanges:
  - EN 1092-1 (DIN 2501)
  - EN 1092-1 (DIN 2512N)
  - ASME B16.5
  - JIS B2220
- Tri-Clamp (OD tubes)
- Clamp (eccentric) :
  - Tri-Clamp
- Threaded hygienic connection:
  - DIN 11851
  - SMS 1145
  - ISO 2853
  - DIN 11864-1 Form A
- Flange:
  - DIN 11864-2 Form A



For information on the materials of the process connections (→ 113)

**16.11 Operability****Local display**

The local display is only available with the following device order code:  
Order code for "Display; Operation", option **B**: 4-line; lit, via communication

**Display element**

- 4-line liquid crystal display with 16 characters per line.
- White background lighting; switches to red in event of device errors.
- Format for displaying measured variables and status variables can be individually configured.
- Permitted ambient temperature for the display:  $-20$  to  $+60$  °C ( $-4$  to  $+140$  °F). The readability of the display may be impaired at temperatures outside the temperature range.

**Disconnecting the local display from the main electronics module**

**i** In the case of the "Compact, aluminum coated" housing version, the local display must only be disconnected manually from the main electronics module. In the case of the "Compact, hygienic, stainless" and "Ultra-compact, hygienic, stainless" housing versions, the local display is integrated in the housing cover and is disconnected from the main electronics module when the housing cover is opened.

*"Compact, aluminum coated" housing version*

The local display is plugged onto the main electronics module. The electronic connection between the local display and main electronics module is established via a connecting cable.

For some work performed on the measuring device (e.g. electrical connection), it is advisable to disconnect the local display from the main electronics module:

1. Press in the side latches of the local display.
2. Remove the local display from the main electronics module. Pay attention to the length of the connecting cable when doing so.

Once the work is completed, plug the local display back on.

## Remote operation

**Via PROFIBUS DP network**

This communication interface is available in device versions with PROFIBUS DP.

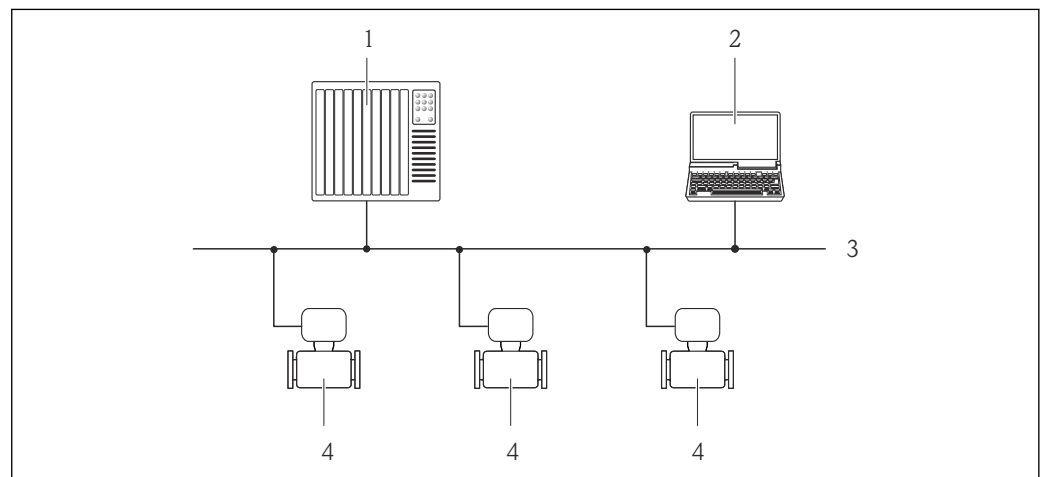

**20** Options for remote operation via PROFIBUS DP network

- 1 Automation system
- 2 Computer with PROFIBUS network card
- 3 PROFIBUS DP network
- 4 Measuring device

Service interface

**Via service interface (CDI-RJ45)**

*PROFIBUS DP*

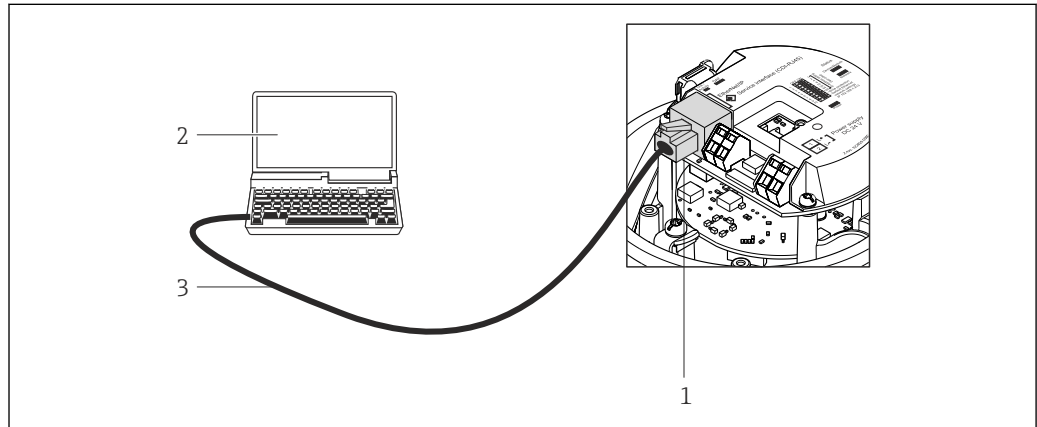

A0021270

21 Connection for order code for "Output", option L: PROFIBUS DP

- 1 Service interface (CDI -RJ45) of the measuring device with access to the integrated Web server
- 2 Computer with Web browser (e.g. Internet Explorer) for accessing the integrated device Web server or with "FieldCare" operating tool with COM DTM "CDI Communication TCP/IP"
- 3 Standard Ethernet connecting cable with RJ45 plug

Languages

Can be operated in the following languages:

- Via "FieldCare" operating tool: English, German, French, Spanish, Italian, Chinese, Japanese
- Via Web browser  
English, German, French, Spanish, Italian, Dutch, Portuguese, Polish, Russian, Turkish, Chinese, Japanese, Bahasa (Indonesian), Vietnamese, Czech

## 16.12 Certificates and approvals

CE mark

The measuring system is in conformity with the statutory requirements of the applicable EC Directives. These are listed in the corresponding EC Declaration of Conformity along with the standards applied.

Endress+Hauser confirms successful testing of the device by affixing to it the CE mark.

C-Tick symbol

The measuring system meets the EMC requirements of the "Australian Communications and Media Authority (ACMA)".

Ex approval

The devices are certified for use in hazardous areas and the relevant safety instructions are provided in the separate "Safety Instructions" (XA) document. Reference is made to this document on the nameplate.

Hygienic compatibility

- 3A approval
- EHEDG-tested

## Certification PROFIBUS

**PROFIBUS interface**

The measuring device is certified and registered by the PROFIBUS User Organization (PNO). The measuring system meets all the requirements of the following specifications:

- Certified in accordance with PROFIBUS PA Profile 3.02
- The device can also be operated with certified devices of other manufacturers (interoperability)

## Pressure Equipment Directive

- With the PED/G1/x (x = category) marking on the sensor nameplate, Endress+Hauser confirms compliance with the "Essential Safety Requirements" specified in Annex I of the Pressure Equipment Directive 97/23/EC.
- Devices not bearing this marking (PED) are designed and manufactured according to good engineering practice. They meet the requirements of Art.3 Section 3 of the Pressure Equipment Directive 97/23/EC. The range of application is indicated in tables 6 to 9 in Annex II of the Pressure Equipment Directive.

## Other standards and guidelines

- EN 60529  
Degrees of protection provided by enclosures (IP code)
- IEC/EN 60068-2-6  
Environmental influences: Test procedure - Test Fc: vibrate (sinusoidal).
- IEC/EN 60068-2-31  
Environmental influences: Test procedure - Test Ec: shocks due to rough handling, primarily for devices.
- EN 61010-1  
Safety requirements for electrical equipment for measurement, control and laboratory use
- IEC/EN 61326  
Emission in accordance with Class A requirements. Electromagnetic compatibility (EMC requirements).
- NAMUR NE 21  
Electromagnetic compatibility (EMC) of industrial process and laboratory control equipment
- NAMUR NE 32  
Data retention in the event of a power failure in field and control instruments with microprocessors
- NAMUR NE 43  
Standardization of the signal level for the breakdown information of digital transmitters with analog output signal.
- NAMUR NE 53  
Software of field devices and signal-processing devices with digital electronics
- NAMUR NE 80  
The application of the pressure equipment directive to process control devices
- NAMUR NE 105  
Specifications for integrating fieldbus devices in engineering tools for field devices
- NAMUR NE 107  
Self-monitoring and diagnosis of field devices
- NAMUR NE 131  
Requirements for field devices for standard applications
- NAMUR NE 132  
Coriolis mass meter

**16.13 Application packages**

Many different application packages are available to enhance the functionality of the device. Such packages might be needed to address safety aspects or specific application requirements.

The application packages can be ordered with the device or subsequently from Endress+Hauser. Detailed information on the order code in question is available from your local Endress+Hauser sales center or on the product page of the Endress+Hauser website: [www.endress.com](http://www.endress.com).

 Detailed information on the application packages:  
Special Documentation on the device

Heartbeat Technology

Package	Description
Heartbeat Verification +Monitoring	<p><b>Heartbeat Monitoring:</b> Continuously supplies monitoring data, which are characteristic of the measuring principle, for an external condition monitoring system. This makes it possible to:</p> <ul style="list-style-type: none"> <li>▪ Draw conclusions - using these data and other information - about the impact the measuring application has on the measuring performance over time.</li> <li>▪ Schedule servicing in time.</li> <li>▪ Monitor the product quality, e.g. gas pockets.</li> </ul> <p><b>Heartbeat Verification:</b> Makes it possible to check the device functionality on demand when the device is installed, without having to interrupt the process.</p> <ul style="list-style-type: none"> <li>▪ Access via onsite operation or other operating interfaces, such as FieldCare for instance.</li> <li>▪ Documentation of device functionality within the framework of manufacturer specifications, for proof testing for instance.</li> <li>▪ End-to-end, traceable documentation of the verification results, including report.</li> <li>▪ Makes it possible to extend calibration intervals in accordance with operator's risk assessment.</li> </ul>



Concentration

Package	Description
Concentration measurement and special density	<p><b>Calculation and outputting of fluid concentrations</b> Many applications use density as a key measured value for monitoring quality or controlling processes. The device measures the density of the fluid as standard and makes this value available to the control system. The "Special Density" application package offers high-precision density measurement over a wide density and temperature range particularly for applications subject to varying process conditions.</p> <p>With the help of the "Concentration Measurement" application package, the measured density is used to calculate other process parameters:</p> <ul style="list-style-type: none"> <li>▪ Temperature-compensated density (reference density).</li> <li>▪ Percentage mass of the individual substances in a two-phase fluid. (Concentration in %).</li> <li>▪ Fluid concentration is output with special units (°Brix, °Baumé, °API, etc.) for standard applications.</li> </ul> <p>The measured values are output via the digital and analog outputs of the device.</p>

Viscosity

Package	Description
Viscosity measurement	<p><b>In-line and real-time viscosity measurement</b> Promass I with the "Viscosity" application package also measures the real-time viscosity of the fluid directly in the process, in addition to measuring the mass flow/volume flow/ temperature and density.</p> <p>The following viscosity measurements are performed on liquids:</p> <ul style="list-style-type: none"> <li>▪ Dynamic viscosity</li> <li>▪ Kinematic viscosity</li> <li>▪ Temperature-compensated viscosity (kinematic and dynamic) in relation to the reference temperature</li> </ul> <p>Viscosity measurement can be used for Newtonian and non-Newtonian applications and supplies accurate measured data irrespective of the flow, even under difficult conditions.</p>

## 16.14 Accessories

 Overview of accessories available for order (→  98)

## 16.15 Documentation

-  For an overview of the scope of the associated Technical Documentation, refer to the following:
- The CD-ROM provided for the device (depending on the device version, the CD-ROM might not be part of the delivery!)
  - The *W@M Device Viewer* : Enter the serial number from the nameplate ([www.endress.com/deviceviewer](http://www.endress.com/deviceviewer))
  - The *Endress+Hauser Operations App*: Enter the serial number from the nameplate or scan the 2-D matrix code (QR code) on the nameplate.

Standard documentation

### Brief Operating Instructions

Measuring device	Documentation code
Promass I 100	KA01117D

### Technical Information

Measuring device	Documentation code
Promass I 100	TI01035D

Supplementary device-dependent documentation



### Safety Instructions

Contents	Documentation code
ATEX/IECEX Ex i	XA00159D
ATEX/IECEX Ex nA	XA01029D
cCSAus IS	XA00160D
INMETRO Ex i	XA01219D
INMETRO Ex nA	XA01220D
NEPSI Ex i	XA01249D
NEPSI Ex nA	XA01262D

### Special Documentation

Contents	Documentation code
Information on the Pressure Equipment Directive	SD00142D
Concentration Measurement	SD01152D
Viscosity measurement	SD01151D
Heartbeat Technology	SD01153D

**Installation instructions**

Contents	Documentation code
Installation Instructions for spare part sets	Specified for each individual accessory (→  98)  Overview of accessories available for order (→  98)



## 17 Appendix

### 17.1 Overview of the operating menu

The following graphic provides an overview of the entire operating menu structure with its menus, submenus and parameters. The page reference indicates where a description of the parameter can be found in the manual.

Depending on the device version, not all submenus and parameters are available in every device. The selection can vary depending on the order code.

For the Order Code "Application Package", the associated parameters are described in the Special Documentation.

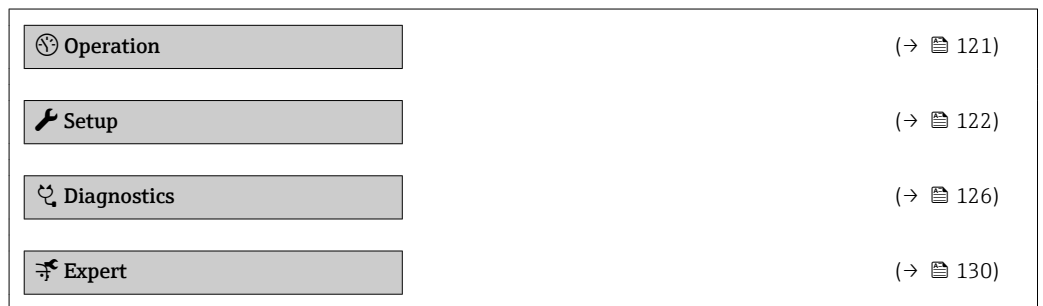

#### 17.1.1 "Operation" menu

Navigation  Operation

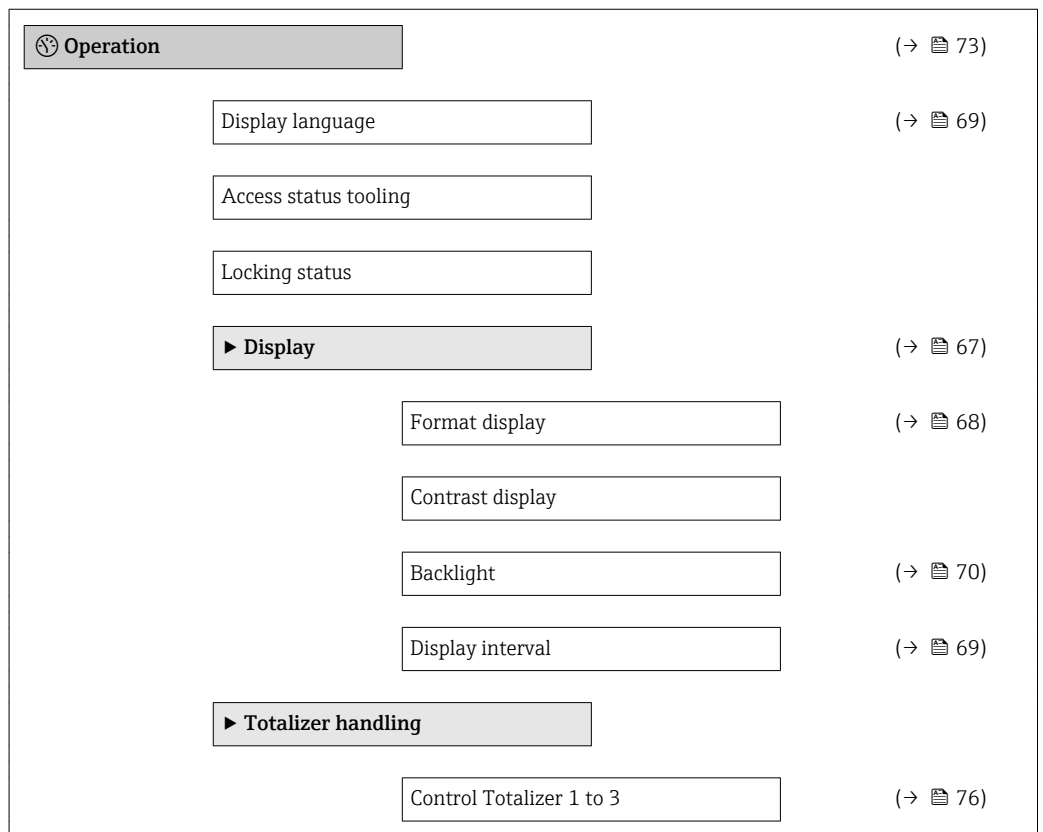

Preset value 1 to 3	(→ 76)
Reset all totalizers	(→ 76)

## 17.1.2 "Setup" menu

Navigation  Setup

<b>Setup</b>	(→ 55)
Device tag	(→ 56)
<b>► System units</b>	
Mass flow unit	(→ 57)
Mass unit	(→ 57)
Volume flow unit	(→ 57)
Volume unit	(→ 57)
Corrected volume flow unit	(→ 57)
Corrected volume unit	(→ 57)
Density unit	(→ 57)
Reference density unit	(→ 57)
Temperature unit	(→ 57)
Pressure unit	(→ 57)
<b>► Medium selection</b>	
Select medium	(→ 58)
Select gas type	(→ 58)
Reference sound velocity	(→ 58)
Temperature coefficient sound velocity	(→ 58)
Pressure compensation	(→ 58)

Pressure value	(→ 58)
External pressure	(→ 58)
► Communication	(→ 59)
Device address	(→ 59)
► Analog inputs	(→ 59)
► Analog input 1 to 8	
Channel	(→ 60)
PV filter time	(→ 60)
Fail safe type	(→ 60)
Fail safe value	(→ 60)
► Low flow cut off	(→ 61)
Assign process variable	(→ 61)
On value low flow cutoff	(→ 61)
Off value low flow cutoff	(→ 61)
Pressure shock suppression	(→ 61)
► Partially filled pipe detection	(→ 62)
Assign process variable	(→ 62)
Low value partial filled pipe detection	(→ 62)
High value partial filled pipe detection	(→ 62)
Response time part. filled pipe detect.	(→ 62)
► Advanced setup	(→ 63)
Enter access code	
► Calculated values	(→ 63)
► Corrected volume flow calculation	
Corrected volume flow calculation	(→ 64)

External reference density	(→ 64)
Fixed reference density	(→ 64)
Reference temperature	(→ 64)
Linear expansion coefficient	(→ 64)
Square expansion coefficient	(→ 64)
<b>► Sensor adjustment</b>	(→ 64)
Installation direction	(→ 65)
<b>► Zero point adjustment</b>	
Zero point adjustment control	(→ 65)
Progress	(→ 65)
<b>► Totalizer 1 to 3</b>	(→ 65)
Assign process variable	(→ 65)
Unit totalizer	(→ 65)
Control Totalizer 1 to 3	(→ 76)
Totalizer operation mode	(→ 66)
Failure mode	(→ 66)
<b>► Display</b>	(→ 67)
Format display	(→ 68)
Value 1 display	(→ 68)
0% bargraph value 1	(→ 68)
100% bargraph value 1	(→ 68)
Decimal places 1	(→ 69)
Value 2 display	(→ 69)
Decimal places 2	(→ 69)
Value 3 display	(→ 69)













0% bargraph value 3	(→ 69)
100% bargraph value 3	(→ 69)
Decimal places 3	(→ 69)
Value 4 display	(→ 69)
Decimal places 4	(→ 69)
Display language	(→ 69)
Display interval	(→ 69)
Display damping	(→ 69)
Header	(→ 69)
Header text	(→ 69)
Separator	(→ 70)
Backlight	(→ 70)
<b>► Viscosity</b>	
<b>► Temperature compensation</b>	
Calculation model	
Reference temperature	
Compensation coefficient X 1	
Compensation coefficient X 2	
<b>► Dynamic viscosity</b>	
Dynamic viscosity unit	
<b>► Kinematic viscosity</b>	
Kinematic viscosity unit	
<b>► Concentration</b>	
Concentration unit	
A 0	

A 1	
A 2	
A 3	
A 4	
B 1	
B 2	
B 3	
▶ Heartbeat setup	
▶ Heartbeat Monitoring	
Activate monitoring	
▶ Administration	(→ ⓘ 91)
Define access code	
Device reset	(→ ⓘ 91)

### 17.1.3 "Diagnostics" menu

Navigation  Diagnostics

🔍 Diagnostics	(→ ⓘ 88)
Actual diagnostics	(→ ⓘ 89)
Timestamp	
Previous diagnostics	(→ ⓘ 89)
Timestamp	
Operating time from restart	
Operating time	
▶ Diagnostic list	
Diagnostics 1	

Timestamp	
Diagnostics 2	
Timestamp	
Diagnostics 3	
Timestamp	
Diagnostics 4	
Timestamp	
Diagnostics 5	
Timestamp	
<b>► Event logbook</b>	
Filter options	
<b>► Device information</b>	(→  92)
Device tag	(→  93)
Serial number	(→  93)
Firmware version	(→  93)
Device name	(→  93)
Order code	(→  93)
Extended order code 1	(→  93)
Extended order code 2	(→  93)
Extended order code 3	(→  93)
ENP version	(→  93)
PROFIBUS ident number	(→  93)
Status PROFIBUS Master Config	(→  93)
IP address	(→  93)

Subnet mask	(→ 93)
Default gateway	(→ 93)
<b>► Measured values</b>	
<b>► Process variables</b>	(→ 73)
Mass flow	(→ 74)
Volume flow	(→ 74)
Corrected volume flow	(→ 74)
Density	(→ 74)
Reference density	(→ 74)
Temperature	(→ 74)
Pressure value	(→ 74)
Dynamic viscosity	
Kinematic viscosity	
Temp. compensated dynamic viscosity	
Temp. compensated kinematic viscosity	
Concentration	
Target mass flow	
Carrier mass flow	
<b>► Totalizer 1 to 3</b>	(→ 74)
Assign process variable	(→ 75)
Totalizer value 1 to 3	(→ 75)
Totalizer status 1 to 3	(→ 75)
Totalizer status (Hex) 1 to 3	(→ 75)



▶ Analog inputs	(→ 59)
▶ Analog input 1 to 8	
Channel	(→ 60)
Out value	
Out status	
Out status	
▶ Heartbeat	
▶ Performing verification	
Year	
Month	
Day	
Hour	
AM/PM	
Minute	
Start verification	
Progress	(→ 65)
Status	
Overall result	
▶ Verification results	
Date/time	
Verification ID	
Operating time	
Overall result	
Sensor	
Sensor integrity	

Sensor electronic module	
I/O module	
► Monitoring results	
Sensor integrity	
► Simulation	(→ 70)
Assign simulation process variable	(→ 71)
Value process variable	(→ 71)
Simulation device alarm	(→ 71)
Simulation diagnostic event	(→ 71)

### 17.1.4 "Expert" menu

The following tables provide an overview of the **Expert** menu with its submenus and parameters. The direct access code to the parameter is given in brackets. The page reference indicates where a description of the parameter can be found in the manual.

















Navigation  Expert

Expert	
--------	--

#### "System" submenu

Navigation   Expert → System













► System	
► Display	(→ 67)
Display language	(→ 69)
Format display	(→ 68)
Value 1 display	(→ 68)
0% bargraph value 1	(→ 68)
100% bargraph value 1	(→ 68)
Decimal places 1	(→ 69)

Value 2 display	(→  69)
Decimal places 2	(→  69)
Value 3 display	(→  69)
0% bargraph value 3	(→  69)
100% bargraph value 3	(→  69)
Decimal places 3	(→  69)
Value 4 display	(→  69)
Decimal places 4	(→  69)
Display interval	(→  69)
Display damping	(→  69)
Header	(→  69)
Header text	(→  69)
Separator	(→  70)
Contrast display	
Backlight	(→  70)
Access status display	
<b>► Diagnostic handling</b>	
Alarm delay	
<b>► Administration</b>	
Define access code	(→  91)
Device reset	(→  91)
Activate SW option	
Software option overview	

**"Sensor" submenu**

Navigation

 Expert → Sensor

▶ Sensor	
▶ Measured values	
▶ Process variables	(→  73)
Mass flow	(→  74)
Volume flow	(→  74)
Corrected volume flow	(→  74)
Density	(→  74)
Reference density	(→  74)
Temperature	(→  74)
Pressure value	(→  74)
Dynamic viscosity	
Kinematic viscosity	
Temp. compensated dynamic viscosity	
Temp. compensated kinematic viscosity	
Concentration	
Target mass flow	
Carrier mass flow	
▶ Totalizer	(→  65)
Totalizer value 1 to 3	(→  75)
Totalizer status (Hex) 1 to 3	(→  75)
Totalizer status 1 to 3	(→  75)
▶ System units	
Mass flow unit	(→  57)

Mass unit	(→ 57)
Volume flow unit	(→ 57)
Volume unit	(→ 57)
Corrected volume flow unit	(→ 57)
Corrected volume unit	(→ 57)
Density unit	(→ 57)
Reference density unit	(→ 57)
Temperature unit	(→ 57)
Pressure unit	(→ 57)
Date/time format	
<b>► Process parameters</b>	
Flow damping	
Density damping	
Temperature damping	
Flow override	
<b>► Low flow cut off</b>	(→ 61)
Assign process variable	(→ 61)
On value low flow cutoff	(→ 61)
Off value low flow cutoff	(→ 61)
Pressure shock suppression	(→ 61)
<b>► Partially filled pipe detection</b>	(→ 62)
Assign process variable	(→ 62)
Low value partial filled pipe detection	(→ 62)
High value partial filled pipe detection	(→ 62)

	Response time part. filled pipe detect.	(→ 62)
	Maximum damping partial filled pipe det.	
<b>► Measurement mode</b>		
	Select medium	(→ 58)
	Select gas type	(→ 58)
	Reference sound velocity	(→ 58)
	Temperature coefficient sound velocity	(→ 58)
<b>► External compensation</b>		
	Pressure compensation	(→ 58)
	Pressure value	(→ 58)
	External pressure	(→ 58)
<b>► Calculated values</b>		
	<b>► Corrected volume flow calculation</b>	
	Corrected volume flow calculation	(→ 64)
	External reference density	(→ 64)
	Fixed reference density	(→ 64)
	Reference temperature	(→ 64)
	Linear expansion coefficient	(→ 64)
	Square expansion coefficient	(→ 64)
<b>► Sensor adjustment</b>		
	Installation direction	(→ 65)

► Zero point adjustment

Zero point adjustment control

(→ ⓘ 65)

Progress

(→ ⓘ 65)

► Process variable adjustment

Mass flow offset

Mass flow factor

Volume flow offset

Volume flow factor

Density offset

Density factor

Corrected volume flow offset

Corrected volume flow factor

Reference density offset

Reference density factor

Temperature offset

Temperature factor

► Calibration

Calibration factor

Zero point

Nominal diameter

C

C

C

C

	C
	C
<b>► Testpoints</b>	
	Oscillation frequency
	Oscillation frequency
	Frequency fluctuation
	Frequency fluctuation
	Oscillation amplitude
	Oscillation amplitude
	Oscillation damping
	Oscillation damping
	Tube damping fluctuation
	Tube damping fluctuation
	Signal asymmetry
	Electronic temperature
	Carrier pipe temperature
	Exciter current
	Exciter current
	RawMassFlow
<b>► Supervision</b>	
	Limit value measuring tube damping



**"Current input" submenu**

Navigation  Expert → Input → Current input

▶ Input

▶ Status input

Assign status input

Value status input

Active level

Response time status input

▶ Output

▶ Pulse/frequency/switch output 1 to 2

Operating mode

Channel 2

Assign pulse output

Value per pulse

Pulse width

Measuring mode

Failure mode

Pulse output

Assign frequency output

Minimum frequency value

Maximum frequency value

Measuring value at maximum frequency

Measuring mode

(→  75)

Damping output	
Failure mode	
Failure frequency	
Output frequency	(→ 75)
Switch output function	
Assign diagnostic behavior	
Assign limit	
Switch-on value	
Switch-off value	
Assign flow direction check	
Assign status	
Failure mode	
Switch status	(→ 75)
Invert output signal	

► Communication	(→ 59)
► PROFIBUS DP configuration	
Address mode	
Device address	(→ 59)
Ident number selector	
► PROFIBUS DP info	
Status PROFIBUS Master Config	(→ 93)
PROFIBUS ident number	(→ 93)
Profile version	
Base current	

Baudrate	
Master availability	
► Physical block	
Device tag	(→ 56)
Static revision	
Strategy	
Alert key	
Target mode	
Mode block actual	
Mode block permitted	
Mode block normal	
Alarm summary	
Software revision	
Hardware revision	
Manufacturer ID	
Device ID	
Serial number	
Diagnostics	
Diagnostics mask	
Device certification	
Factory reset	
Descriptor	
Device message	
Device install date	
Ident number selector	

Hardware lock	
Feature supported	
Feature enabled	
Condensed status diagnostic	
<b>► Web server</b>	(→ 43)
Web server language	
MAC address	
IP address	(→ 93)
Subnet mask	(→ 93)
Default gateway	(→ 93)
Web server functionality	(→ 43)
<b>► Channel Configuration</b>	

<b>► Application</b>	
<b>► Totalizer 1 to 3</b>	(→ 65)
Tag description	
Static revision	
Strategy	
Alert key	
Target mode	
Mode block actual	
Mode block permitted	
Mode block normal	
Alarm summary	
Batch ID	

Batch operation	
Batch phase	
Batch Recipe Unit Procedure	
Totalizer value 1 to 3	(→ 75)
Totalizer status 1 to 3	(→ 75)
Totalizer status (Hex) 1 to 3	(→ 75)
Unit totalizer	(→ 65)
Assign process variable	(→ 65)
Control Totalizer 1 to 3	(→ 76)
Totalizer operation mode	(→ 66)
Failure mode	(→ 66)
Preset value 1 to 3	(→ 76)
Alarm hysteresis	
Hi Hi Lim	
Hi Lim	
Lo Lim	
Lo Lo Lim	
Hi Hi alarm value	
Hi Hi alarm state	
Hi alarm value	
Hi alarm state	
Lo alarm value	
Lo alarm state	
Lo Lo alarm value	
Lo Lo alarm state	

<b>► Viscosity</b>	
Viscosity damping	
<b>► Temperature compensation</b>	
Calculation model	
Reference temperature	
Compensation coefficient X 1	
Compensation coefficient X 2	
<b>► Dynamic viscosity</b>	
Dynamic viscosity unit	
<b>► Kinematic viscosity</b>	
Kinematic viscosity unit	
<b>► Concentration</b>	
Concentration damping	
Concentration unit	
A 0	
A 1	
A 2	
A 3	
A 4	
B 1	
B 2	
B 3	

<b>► Diagnostics</b>	(→ ⓘ 88)
Actual diagnostics	(→ ⓘ 89)

Timestamp	
Previous diagnostics	(→ 89)
Timestamp	
Operating time from restart	
Operating time	
<b>► Diagnostic list</b>	
Diagnostics 1	
Timestamp	
Diagnostics 2	
Timestamp	
Diagnostics 3	
Timestamp	
Diagnostics 4	
Timestamp	
Diagnostics 5	
Timestamp	
<b>► Event logbook</b>	
Filter options	
<b>► Device information</b>	(→ 92)
Device tag	(→ 93)
Serial number	(→ 93)
Firmware version	(→ 93)
Device name	(→ 93)
Order code	(→ 93)
Extended order code 1	(→ 93)

Extended order code 2	(→ ⓘ 93)
Extended order code 3	(→ ⓘ 93)
ENP version	(→ ⓘ 93)
<b>▶ Min/max values</b>	
Reset min/max values	
<b>▶ Electronic temperature</b>	
Minimum value	
Maximum value	
<b>▶ Medium temperature</b>	
Minimum value	
Maximum value	
<b>▶ Carrier pipe temperature</b>	
Minimum value	
Maximum value	
<b>▶ Oscillation frequency</b>	
Minimum value	
Maximum value	
<b>▶ Torsion oscillation frequency</b>	
Minimum value	
Maximum value	
<b>▶ Oscillation amplitude</b>	
Minimum value	
Maximum value	



<b>► Torsion oscillation amplitude</b>	
<input type="text" value="Minimum value"/>	
<input type="text" value="Maximum value"/>	
<b>► Oscillation damping</b>	
<input type="text" value="Minimum value"/>	
<input type="text" value="Maximum value"/>	
<b>► Torsion oscillation damping</b>	
<input type="text" value="Minimum value"/>	
<input type="text" value="Maximum value"/>	
<b>► Signal asymmetry</b>	
<input type="text" value="Minimum value"/>	
<input type="text" value="Maximum value"/>	
<b>► Heartbeat</b>	
<b>► Performing verification</b>	
<input type="text" value="Year"/>	
<input type="text" value="Month"/>	
<input type="text" value="Day"/>	
<input type="text" value="Hour"/>	
<input type="text" value="AM/PM"/>	
<input type="text" value="Minute"/>	
<input type="text" value="Start verification"/>	
<input type="text" value="Progress"/>	
<input type="text" value="Status"/>	
<input type="text" value="Overall result"/>	

(→  65)

▶ Verification results	
Date/time	
Verification ID	
Operating time	
Overall result	
Sensor	
Sensor integrity	
Sensor electronic module	
I/O module	
▶ Heartbeat Monitoring	
Activate monitoring	
▶ Monitoring results	
Sensor integrity	
▶ Simulation	(→ 📄 70)
Assign simulation process variable	(→ 📄 71)
Value process variable	(→ 📄 71)
Simulation device alarm	(→ 📄 71)
Simulation diagnostic event	(→ 📄 71)

# Index

## A

- Accuracy . . . . . 104
- Adapting the diagnostic behavior . . . . . 83
- Ambient temperature range . . . . . 21
- Application . . . . . 9, 100
- Application packages . . . . . 117
- Applicator . . . . . 101
- Approvals . . . . . 116

## C

- C-Tick symbol . . . . . 116
- Cable entries
  - Technical data . . . . . 104
- Cable entry
  - Degree of protection . . . . . 35
- CE mark . . . . . 10, 116
- Certificates . . . . . 116
- Certification PROFIBUS . . . . . 117
- Check
  - Installation . . . . . 27
- Checklist
  - Post-connection check . . . . . 36
  - Post-installation check . . . . . 27
- Cleaning
  - Cleaning in place (CIP) . . . . . 95
  - Exterior cleaning . . . . . 95
  - Interior cleaning . . . . . 95
  - Sterilization in place (SIP) . . . . . 95
- Cleaning in place (CIP) . . . . . 109
- Climate class . . . . . 109
- Commissioning . . . . . 55
  - Advanced settings . . . . . 63
  - Configuring the measuring device . . . . . 55
- Compatibility with earlier model . . . . . 47
- Connecting cable . . . . . 29
- Connecting the measuring device . . . . . 31
- Connection
  - see Electrical connection
- Connection preparations . . . . . 31
- Connection tools . . . . . 29
- Current consumption . . . . . 104
- Current input (Submenu) . . . . . 137
- Cyclic data transmission . . . . . 48

## D

- Declaration of Conformity . . . . . 10
- Define access code . . . . . 72
- Degree of protection . . . . . 35, 109
- Density . . . . . 109
- Design
  - Measuring device . . . . . 12
- Design fundamentals
  - Maximum measured error . . . . . 107
  - Repeatability . . . . . 107
- Designated use . . . . . 9
- Device components . . . . . 12

- Device description files . . . . . 47
- Device documentation
  - Supplementary documentation . . . . . 8
- Device locking, status . . . . . 73
- Device master file
  - GSD . . . . . 47
- Device name
  - Sensor . . . . . 15
  - Transmitter . . . . . 14
- Device repair . . . . . 96
- Device revision . . . . . 47
- Device type ID . . . . . 47
- Diagnostic behavior
  - Explanation . . . . . 80
  - Symbols . . . . . 80
- Diagnostic information
  - Design, description . . . . . 80, 83
  - FieldCare . . . . . 81
  - Light emitting diodes . . . . . 78
  - Local display . . . . . 79
  - Overview . . . . . 85
  - Remedial measures . . . . . 85
- Diagnostic list . . . . . 89
- Diagnostic message . . . . . 79
- Diagnostics
  - Symbols . . . . . 79
- Diagnostics (Menu) . . . . . 126
- DIP switch
  - see Write protection switch
- Disabling write protection . . . . . 71
- Display
  - Current diagnostic event . . . . . 88
  - Previous diagnostic event . . . . . 88
- Display values
  - For locking status . . . . . 73
- Disposal . . . . . 96
- Document
  - Function . . . . . 6
  - Symbols used . . . . . 6
- Document function . . . . . 6
- Down pipe . . . . . 19

## E

- Electrical connection
  - Degree of protection . . . . . 35
  - Measuring device . . . . . 29
  - Operating tools
    - Via PROFIBUS DP network . . . . . 43, 115
    - Via service interface (CDI-RJ45) . . . . . 44, 116
    - Web server . . . . . 44, 116
- Electromagnetic compatibility . . . . . 109
- Enabling write protection . . . . . 71
- Endress+Hauser services
  - Maintenance . . . . . 95
  - Repair . . . . . 96
- Environment

- Storage temperature . . . . . 109
  - Error messages
    - see Diagnostic messages
  - Event history . . . . . 89
  - Events list . . . . . 89
  - Ex approval . . . . . 116
  - Expert (Menu) . . . . . 130
  - Extended order code
    - Sensor . . . . . 15
    - Transmitter . . . . . 14
  - Exterior cleaning . . . . . 95
- F**
- Field of application
    - Residual risks . . . . . 10
  - FieldCare . . . . . 44
    - Device description file . . . . . 47
    - Establishing a connection . . . . . 45
    - Function . . . . . 44
    - User interface . . . . . 46
  - Filtering the event logbook . . . . . 90
  - Firmware
    - Release date . . . . . 47
    - Version . . . . . 47
  - Firmware history . . . . . 93
  - Flow direction . . . . . 20, 26
  - Flow limit . . . . . 110
  - Function check . . . . . 55
  - Functions
    - see Parameters
- G**
- Galvanic isolation . . . . . 102
- H**
- Hardware write protection . . . . . 72
  - Hygienic compatibility . . . . . 116
- I**
- I/O electronics module . . . . . 12, 32
  - Identifying the measuring device . . . . . 13
  - Incoming acceptance . . . . . 13
  - Influence
    - Medium pressure . . . . . 107
    - Medium temperature . . . . . 106
  - Information on the document . . . . . 6
  - Inlet runs . . . . . 20
  - Input . . . . . 100
  - Inspection
    - Received goods . . . . . 13
  - Inspection check
    - Connection . . . . . 36
  - Installation . . . . . 19
  - Installation conditions
    - Down pipe . . . . . 19
    - Mounting location . . . . . 19
    - System pressure . . . . . 21
    - Thermal insulation . . . . . 21
    - Vibrations . . . . . 24
  - Installation dimensions . . . . . 21
- Interior cleaning . . . . . 95, 109
- L**
- Languages, operation options . . . . . 116
  - Local display
    - see Diagnostic message
    - see In alarm condition
  - Low flow cut off . . . . . 102
- M**
- Main electronics module . . . . . 12
  - Maintenance tasks . . . . . 95
  - Manufacturer ID . . . . . 47
  - Manufacturing date . . . . . 14, 15
  - Materials . . . . . 113
  - Maximum measured error . . . . . 105
  - Measured variables
    - see Process variables
  - Measuring and test equipment . . . . . 95
  - Measuring device
    - Configuration . . . . . 55
    - Conversion . . . . . 96
    - Design . . . . . 12
    - Disposal . . . . . 97
    - Mounting the sensor . . . . . 26
    - Preparing for electrical connection . . . . . 31
    - Preparing for mounting . . . . . 26
    - Removing . . . . . 96
    - Repair . . . . . 96
  - Measuring principle . . . . . 100
  - Measuring range
    - Calculation example for gas . . . . . 101
    - For gases . . . . . 101
    - For liquids . . . . . 100
  - Measuring range, recommended . . . . . 110
  - Measuring system . . . . . 100
  - Media . . . . . 9
  - Medium pressure
    - Influence . . . . . 107
  - Medium temperature
    - Influence . . . . . 106
  - Menu
    - Diagnostics . . . . . 88, 126
    - Expert . . . . . 130
    - Operation . . . . . 73, 121
    - Setup . . . . . 55, 122
  - Menus
    - For measuring device configuration . . . . . 55
    - For specific settings . . . . . 63
  - Mounting dimensions
    - see Installation dimensions
  - Mounting location . . . . . 19
  - Mounting preparations . . . . . 26
  - Mounting requirements
    - Inlet and outlet runs . . . . . 20
    - Installation dimensions . . . . . 21
    - Orientation . . . . . 20
    - Sensor heating . . . . . 23
  - Mounting tools . . . . . 26

**N**

Nameplate	
Sensor	15
Transmitter	14
Nominal pressure	
Secondary containment	110

**O**

Operable flow range	101
Operating elements	80
Operating menu	
Menus, submenus	38
Overview of menus with parameters	121
Structure	38
Submenus and user roles	39
Operating philosophy	39
Operation	73
Operation (Menu)	121
Operation options	37
Operational safety	10
Order code	14, 15
Orientation (vertical, horizontal)	20
Outlet runs	20
Output	102
Output signal	102
Overview	
Operating menu	121

**P**

Packaging disposal	18
Parameter settings	
Administration (Submenu)	91
Analog inputs (Submenu)	59
Calculated values (Submenu)	63
Communication (Submenu)	59
Device information (Submenu)	92
Diagnostics (Menu)	88
Display (Submenu)	67
Low flow cut off (Wizard)	61
Operation (Submenu)	76
Output values (Submenu)	75
Partially filled pipe detection (Wizard)	62
Process variables (Submenu)	73
Select medium (Submenu)	58
Sensor adjustment (Submenu)	64
Setup (Menu)	55
Simulation (Submenu)	70
Totalizer 1 to 3 (Submenu)	65, 74
Web server (Submenu)	43
Performance characteristics	104
Post-connection check (checklist)	36
Post-installation check	55
Post-installation check (checklist)	27
Potential equalization	33
Power consumption	104
Power supply failure	104
Pressure Equipment Directive	117
Pressure loss	111
Pressure-temperature ratings	109

Process connections	114
Process variables	
Calculated	100
Measured	100
Product safety	10
Protecting parameter settings	71

**R**

Reading measured values	73
Recalibration	95
Reference operating conditions	104
Registered trademarks	8
Remedial measures	
Calling up	81
Closing	81
Remote operation	115
Repair	96
Notes	96
Repair of a device	96
Repeatability	106
Replacement	
Device components	96
Requirements for personnel	9
Response time	106
Return	96

**S**

Safety	9
Seals	
Medium temperature range	109
Sensor	
Medium temperature range	109
Mounting	26
Sensor (Submenu)	132
Sensor heating	23
Serial number	14, 15
Setting the operating language	55
Settings	
Adapting the measuring device to the process conditions	76
Advanced display configurations	67
Analog input	59
Communication interface	59
Device reset	91
Device tag	55
Low flow cut off	61
Medium	58
Operating language	55
Partial filled pipe detection	62
Resetting the totalizer	76
Sensor adjustment	64
Simulation	70
System units	56
Totalizer	65
Totalizer reset	76
Setup (Menu)	122
Shock resistance	109
Signal on alarm	102
Software release	47

- Spare part . . . . . 96
  - Spare parts . . . . . 96
  - Special connection instructions . . . . . 33
  - Standards and guidelines . . . . . 117
  - Status signals . . . . . 79, 82
  - Sterilization in place (SIP) . . . . . 109
  - Storage conditions . . . . . 17
  - Storage temperature . . . . . 17
  - Storage temperature range . . . . . 109
  - Structure
    - Operating menu . . . . . 38
  - Submenu
    - Administration . . . . . 91
    - Advanced setup . . . . . 63
    - Analog inputs . . . . . 59
    - Calculated values . . . . . 63
    - Communication . . . . . 59
    - Current input . . . . . 137
    - Define access code . . . . . 71
    - Device information . . . . . 92
    - Display . . . . . 67
    - Events list . . . . . 89
    - Operation . . . . . 76
    - Output values . . . . . 75
    - Overview . . . . . 39
    - Process variables . . . . . 63, 73
    - Select medium . . . . . 58
    - Sensor . . . . . 132
    - Sensor adjustment . . . . . 64
    - Simulation . . . . . 70
    - System . . . . . 130
    - Totalizer 1 to 3 . . . . . 65, 74
    - Web server . . . . . 43
  - Supply voltage . . . . . 104
  - System (Submenu) . . . . . 130
  - System design
    - Measuring system . . . . . 100
    - see Measuring device design
  - System integration . . . . . 47
  - System pressure . . . . . 21
- T**
- Technical data, overview . . . . . 100
  - Temperature range
    - Medium temperature . . . . . 109
    - Storage temperature . . . . . 17
  - Terminal assignment . . . . . 30, 32
  - Terminals . . . . . 104
  - Thermal insulation . . . . . 21
  - Tools
    - Electrical connection . . . . . 29
    - Installation . . . . . 26
    - Transport . . . . . 17
  - Transmitter
    - Connecting the signal cables . . . . . 32
    - Turning the display module . . . . . 26
  - Transporting the measuring device . . . . . 17
  - Troubleshooting
    - General . . . . . 77
  - Turning the display module . . . . . 26
- U**
- Use of the measuring device
    - Borderline cases . . . . . 9
    - Incorrect use . . . . . 9
    - see Designated use
  - User roles . . . . . 39
- V**
- Version data for the device . . . . . 47
  - Vibration resistance . . . . . 109
  - Vibrations . . . . . 24
- W**
- W@M . . . . . 95, 96
  - W@M Device Viewer . . . . . 13, 96
  - Weight
    - SI units . . . . . 112
    - Transport (notes) . . . . . 17
    - US units . . . . . 112
  - Wizard
    - Define access code . . . . . 71
    - Low flow cut off . . . . . 61
    - Partially filled pipe detection . . . . . 62
  - Workplace safety . . . . . 10
  - Write protection
    - Via access code . . . . . 71
    - Via write protection switch . . . . . 72
  - Write protection switch . . . . . 72



[www.addresses.endress.com](http://www.addresses.endress.com)

---